

# PROPORTIONAL PRESSURE REGULATORS

PRINCIPLE	DESCRIPTION	ACCURACY max.	PRESSURE RANGE bar	CONNECTION thread	DEVICE	PAGE
<b>CONTROL VALVE</b> high accuracy	on PCB	± 0.2 %	0 ... 0.005/ 10	G $\frac{1}{8}$	PM	<b>10.02</b>
	falling characteristic	± 0.2 %	0 ... 0.005/ 35	G $\frac{1}{8}$	PQ1	<b>10.04</b>
	with double loop	± 0.2 %	0 ... 0.005/ 35	G $\frac{1}{8}$	PQ2	<b>10.05</b>
	up to 2000 l/min	± 0.25 %	0 ... 0.1 / 35	¼"NPT - ¾"NPT	PQ3...PQ6	<b>10.06</b>
<b>PROPORT. MAGNET</b> very robust	proven, many options	± 0.5 %	0 ... 0.5 / 1	G $\frac{1}{8}$ - G1	PR	<b>10.09</b>
	for flow applications	± 0.5 %	0 ... 6 / 50	G $\frac{3}{8}$	PF	<b>10.12</b>
	digital control, also SST	± 0.5 %	0 ... 0.1 / 50	G $\frac{1}{8}$ - G1	PP	<b>10.13</b>
	programmable	± 0.5 %	0 ... 1 / 12	G $\frac{1}{8}$ - G $\frac{3}{8}$	PD	<b>10.15</b>
<b>FLAPPER/NOZZLE</b> highly sensitive	integrated booster, Atex	± 0.5 %	0,2... 1 / 8	¼"NPT	PT6	<b>10.19</b>
<b>PIEZO-OPERATED</b> very fast	high accurate, Atex	± 0.25 %	0,2... 1 / 8	¼"NPT	PT7	<b>10.20</b>
	minimal power consumption	± 0.2 %	0 ... 0.1 / 16	G $\frac{1}{8}$ and G $\frac{1}{4}$	PRE	<b>10.21</b>
<b>MOTORISED REGUL.</b>	failfreeze	± 1 %	0,14... 1.8 / 8	¼"NPT	P180	www*
<b>HIGH PRESSURE</b>	proportional magnet	± 0.5 %	0 ... 30 / 50	G $\frac{1}{4}$	PP0	<b>10.13</b>
	control valves	± 0.5 %	0 ... 40 / 70	G $\frac{1}{8}$	PQH	<b>10.18</b>
<b>ATEX</b>	control valves	± 1 %	0 ... 2 / 6	G $\frac{1}{8}$	PCEX	<b>10.17</b>
	flapper nozzle	± 0.5 %	0,2... 1 / 8	¼"NPT	PT6	<b>10.19</b>
	piezo-operated	± 0.25 %	0,2... 1 / 8	¼"NPT	PT7	<b>10.20</b>
<b>VACUUM</b>	on PCB	± 0.2 %	-1 ... 0 / + 1	G $\frac{1}{8}$	PM	<b>10.02</b>
	control valves	± 0.2 %	-1 ... 0 / + 1	G $\frac{1}{8}$	PQ1	<b>10.04</b>
	with double loop	± 0.2 %	-1 ... 0 / + 1	G $\frac{1}{8}$	PQ2	<b>10.05</b>
	proportional magnet	± 0.5 %	-1 ... 0 / + 1	G $\frac{1}{8}$ - G1	PR	<b>10.09</b>
	digital control	± 0.5 %	-1 ... 0	G $\frac{1}{8}$ - G1	PP	<b>10.13</b>
	piezo-operated	± 0.2 %	-1 ... 1 / +10	G $\frac{1}{8}$ and G $\frac{1}{4}$	PRE	<b>10.21</b>
<b>IO-LINK SETPOINT</b>	digital control	± 1,5 %	0 ... 3 / 10	G $\frac{1}{4}$ - G $\frac{1}{2}$	PIO	<b>10.23</b>
	with 10-speed-potentiometer				PPB	<b>10.24</b>



# 10

\* visit our webshop: [www.aircom.net](http://www.aircom.net)

<b>Description</b>	Proportional pressure regulator with closed loop control technology for better control of pressurised gases. The instrument can be built as single closed loop or dual closed loop control valve. dry, lubricated or unlubricated and 5 µm filtered compressed air or non-corrosive gases	
<b>Media</b>	constant outlet pressure at voltage drop	
<b>Fail freeze</b>	0 ... 10 V, impedance 4.7 kΩ,	ratio of internal to external relationship is 10% to 90%
<b>Second loop</b>	15 ... 24 V DC, residual ripple < 10%, with reverse voltage protection	jumper selectable command
<b>Supply voltage</b>	0 ... 10 V / 4.7 kΩ, 4 ... 20 mA / 100 Ω,	
<b>Impedance</b>	0 ... 10 V at max. 10 mA	
<b>Monitor signal</b>	terminal strip for 2.5 mm <sup>2</sup>	
<b>Electrical connection</b>	3.6 W regulating, 0.5 W non-regulating	<b>Air consumption</b> without constant bleed
<b>Power consumption</b>	< 0.15% FS	<b>Repeatability</b> < 0.02 FS
<b>Linearity / Hysteresis</b>	< 1% FS at 0 °C to 50 °C / 32 °F to 122 °F	<b>Adjustment</b> zero point and span
<b>Temperature influence</b>	0 °C to 70 °C / 32 °F to 158 °F	<b>Mounting position</b> any, vibration-resistant
<b>Temperature range</b>	Ports: brass	<b>Elastomer:</b> FKM
<b>Material</b>	Transducer: aluminium and silicon	<b>Valves:</b> nickel-plated brass

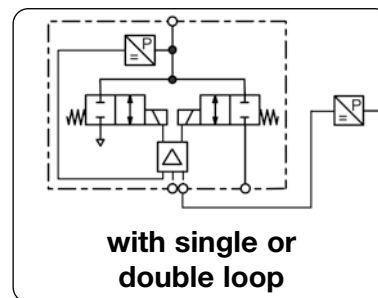

Dimensions			Flow rate	Supply pressure	Accuracy	Connection thread	Pressure range	Order number
A	B	C	l/min*1	max. mbar/bar	%	G	mbar/bar	
mm	mm	mm						E*

Proportional press. regulator								0-10 V input and monitor signal, supply voltage 24 V DC, fail freeze, single loop for DIN rail	PM
56	78	54	35	10 mbar	0.2	G $\frac{1}{2}$	0 ... 5 mbar	PM1DE-A5	
				20 mbar			0 ... 10 mbar	PM1DE-B1	
				200 mbar			0 ... 100 mbar	PM1DE-C1	
				1 000 mbar			0 ... 600 mbar	PM1DE-C6	
56	78	54	35	2 bar	0.2	G $\frac{1}{2}$	0 ... 1 bar	PM1DE-01	
				3 bar			0 ... 2 bar	PM1DE-02	
				9 bar			0 ... 4 bar	PM1DE-04	
				9 bar			0 ... 6 bar	PM1DE-06	
				15 bar			0 ... 10 bar	PM1DE-10	
56	78	54	35	2 bar	0.2	G $\frac{1}{2}$	0 ... -1 bar	PM1DE-V0	
				2 bar			-1 ... +1 bar	PM1DE-V1	



**PM . D**  
DIN rail mounting



**PM . P**  
panel mounting



**PM . M**  
mounting on manifold block

## Special options, add the appropriate letter

<b>double loop</b>	second loop feedback 0 ...10 V	PM2 . . . .
<b>4-20 mA</b>	supply signal, jumper selectable command	PM . . . . I . . .
<b>flow 100 l/min</b>	increased flow rate	PM . . . . HF
<b>panel mounting</b>	on plane level	PM . P . . .
<b>mounting for manifolds</b>	connections downwards	PM . M . . .

## Accessories, enclosed

**manifold block** for 2 to 7 valves number of valves added to order number **SBM-**

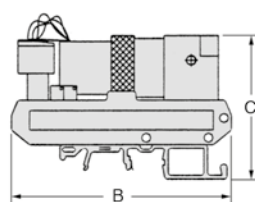

**PM . D for DIN rail**

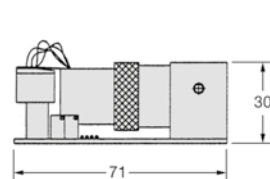

**PM . P for panel mounting**

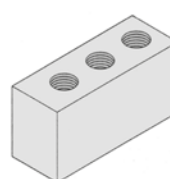

**PM . D for DIN rail**

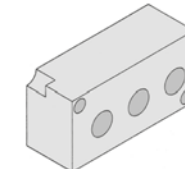
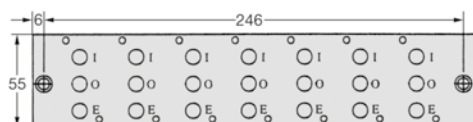

**PM . M for manifold block**

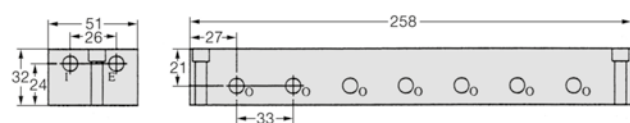

**manifold block for 2 to 7 valves**

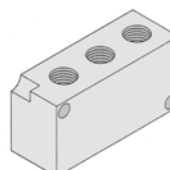

**PM . P for panel mounting**

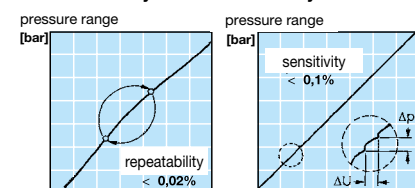
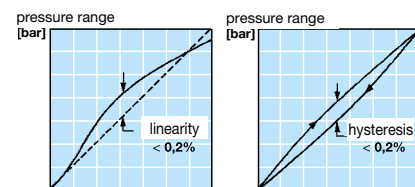

\* Product group

\*1 at 7 bar supply pressure and open outlet, at regulated flow rate of 3 l/min  
\*2 higher supply pressures on request

For further details about double loop see PQ2

PDF CAD  
www.aircom.net

**Order example:**  
PM1DE-A5

**Technical features**

• <b>Pressure range</b>	0...10 mbar up to 0...35 bar	• <b>Linearity</b>	± 0.15% FS
• <b>Input signal</b>	0...10 V and 4...20 mA	• <b>Hysteresis</b>	± 0.15% FS
• <b>Security</b>	constant outlet pressure at voltage drop	• <b>Response sensitivity</b>	< 0.1% FS
• <b>Response time</b>	10 to 15 ms	• <b>Repeatability</b>	± 0.02% FS
• <b>Adjustment</b>	zero point and span	• <b>Protection class</b>	IP 65
• <b>Sensitivity</b>	immune to shock and vibration up to 25 g	• <b>Air consumption</b>	without constant bleed

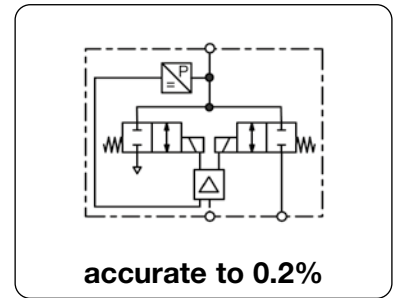

**General technical features**

<b>Description</b>	Two solenoid valves control the system pressure. One valve is for inlet control, the other for outlet control. A strain gauge pressure transducer measures system pressure and provides a feedback signal to the electronic controls. Any difference between command and feedback signals causes one of the solenoid valves to open, causing system pressure to increase or decrease.		
<b>Mounting position</b>	any, immune to shock and vibration up to 25 g		
<b>Protection class</b>	IP 65 housing		
<b>Temperature range</b>	-5 °C to 70 °C / 23 °F to 158 °F		
<b>Material</b>	Body: aluminium	Elastomer: FKM	
	Transducer: aluminium and silicon	Valves: nickel-plated brass	

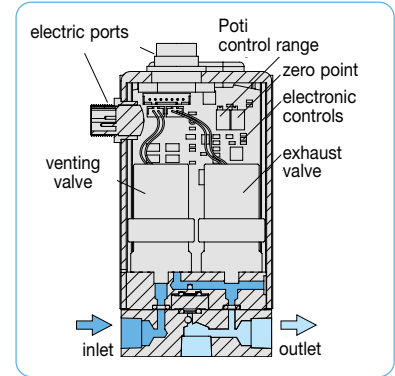

**Pneumatic features**

<b>Media</b>	dry, un lubricated and 5 µm filtered compressed air or non-corrosive gases
<b>Supply pressure</b>	see chart, minimum 10% above outlet pressure
<b>Flow rate</b>	35 l/min at 7 bar supply pressure and open outlet, optionally 100 l/min 3 l/min at controlled outlet pressure
<b>Exhaust</b>	same nominal size as on inlet valve, thus same relief capacity
<b>Air consumption</b>	without constant bleed, Option X58: < 2 l/min

**Electrical features**

<b>Supply voltage</b>	15 ... 24 V DC, reverse voltage protection existing
<b>Power consumption</b>	3.6 W for regulation, 0.5 W non-regulating
<b>Signal range</b>	0 ... 10 V, optionally 4 ... 20 mA
<b>Impedance</b>	4.7 kΩ at voltage signal, 100 Ω at current signal 10 kΩ at voltage signal, 100 Ω at current signal, for external feedback
<b>Monitor signal impedance</b>	> 4.7 kΩ at voltage signal, < 100 Ω at current signal
<b>Electrical connector</b>	plug M16x0.75, 7-pin, with coupling socket
<b>Monitor signal</b>	0 ... 10 V, optionally 4 ... 20 mA
<b>Security</b>	constant outlet pressure at voltage drop

**Accuracy**

<b>Linearity/Hysteresis</b>	± 0.15% FS
<b>Response sensitivity</b>	< 0.1% FS
<b>Response time</b>	10 to 15 ms
<b>Repeatability</b>	± 0.02% FS
<b>Temperature influence</b>	< 0.01% FS per °C/K at 0 °C to 50 °C / 32 °F to 122 °F < 1.00% FS per °C/K at 50 °C to 70 °C / 122 °F to 158 °F
<b>Accuracy over all</b>	± 0.2 % FS
<b>Regulating time</b>	< 2 s to fill 0.1 l volume to 90% of the initial pressure (or to exhaust) < 40 s to fill 2 l volume to 90% of the initial pressure (< 80 s to exhaust)

**Adjustment**

<b>Zero point</b>	The zero point can be increased by up to 20% of full scale, e.g. from 0 bar to 1.2 bar at a 6 bar regulator. External adjustment via potentiometer Z "zero".
<b>Span</b>	The maximum pressure value of the control range can be reduced by up to 20% depending on the selected pressure range, e.g. from 6 to 4.8 bar. External adjustment via potentiometer S "span".

\*1 at 7 bar supply pressure and 3 bar outlet pressure

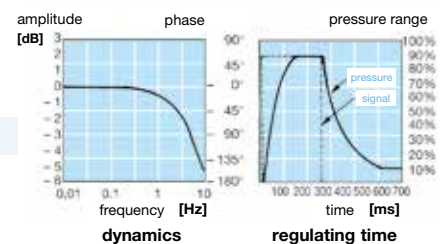
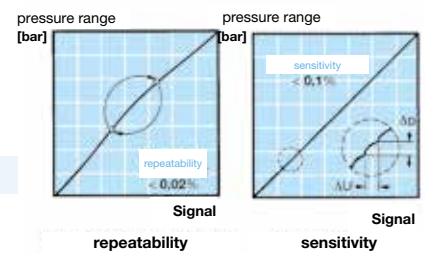
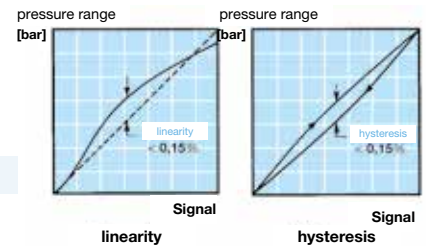

<b>Description</b>	The pneumatic proportional pressure regulator produces outlet pressure in proportion to an electrical command input signal. It comprises a complete closed loop servo system consisting of valves, manifold, housing and electronic controls.
<b>Single loop</b>	Pressure is controlled by two solenoid valves. One valve functions as inlet control, the other as exhaust. The pressure outlet is measured by an internal pressure transducer which provides a feedback signal to the electronic controls. This feedback signal is compared with the command input signal. Any difference between the two signals causes one of the two solenoid valves to open, allowing flow into or out of the system. Accurate pressure is maintained by these two valves.
<b>Accuracy</b>	Linearity / Hysteresis: ± 0.15% FS Response sensitivity: < 0.1% FS Repeatability: ± 0.02% FS Accuracy over all: ± 0.2% FS

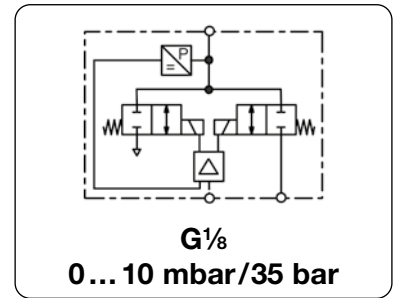

Dimensions			Flow rate	Supply pressure	Accuracy	Connection thread	Pressure range	Order number
A	B	C	l/min*1	max. mbar/bar*2	%	G	mbar/bar	E*

Single loop regulator				0 ... 10 V input and feedback signal, supply voltage 24 V DC, 35 l/min*1, with coupling socket				PQ1
51	106	8	on request	10 mbar	0.2	G <sup>1</sup> / <sub>8</sub>	0 ... 5 mbar	<b>PQ1EE-A5</b>
				20 mbar			0 ... 10 mbar	<b>PQ1EE-B1</b>
				40 mbar			0 ... 20 mbar	<b>PQ1EE-B2</b>
				100 mbar			0 ... 50 mbar	<b>PQ1EE-B5</b>
				200 mbar			0 ... 100 mbar	<b>PQ1EE-C1</b>
				400 mbar			0 ... 200 mbar	<b>PQ1EE-C2</b>
				800 mbar			0 ... 400 mbar	<b>PQ1EE-C4</b>
				1 000 mbar			0 ... 600 mbar	<b>PQ1EE-C6</b>
51	106	8	35	2 bar	0.2	G <sup>1</sup> / <sub>8</sub>	0 ... 1 bar	<b>PQ1EE-01</b>
				3 bar			0 ... 2 bar	<b>PQ1EE-02</b>
				7 bar			0 ... 4 bar	<b>PQ1EE-04</b>
				7 bar			0 ... 6 bar	<b>PQ1EE-06</b>
				9 bar			0 ... 8 bar	<b>PQ1EE-08</b>
				15 bar			0 ... 10 bar	<b>PQ1EE-10</b>
				15 bar			0 ... 12 bar	<b>PQ1EE-12</b>
				24 bar			0 ... 16 bar	<b>PQ1EE-16</b>
				24 bar			0 ... 20 bar	<b>PQ1EE-20</b>
				38 bar			0 ... 25 bar	<b>PQ1EE-25</b>
				38 bar			0 ... 30 bar	<b>PQ1EE-30</b>
				38 bar			0 ... 35 bar	<b>PQ1EE-35</b>
51	106	8	35	0 bar	0.2	G <sup>1</sup> / <sub>8</sub>	0 ... -1 bar	<b>PQ1EE-V0</b>
				2 bar			-1 ... +1 bar	<b>PQ1EE-V1</b>



PQ1

### Special options, add the appropriate letter or number

<b>4-20 mA</b>	input and monitor signal	PQ1 IC- . . .
<b>flow 100 l/min</b>	increased flow rate, max. 10 bar, not combinable with Opt. . .X58	PQ1 . . . . .HF
<b>continuous regulation*3</b>	improved characteristic curve through proportional inlet valve, max. 10 bar	PQ1 . . . . .X58
<b>declining curve</b>	inverted outlet	PQ1 . . . . .X59

### Accessories, enclosed

<b>coupling socket</b>	M16x0,75, 7-pin with 2 m cable	straight	<b>PRK-A2L</b>
		angular	<b>PRK-C2L</b>
<b>mounting bracket</b>	made of steel		<b>PQKT-01</b>



PRK-A

PRK-C

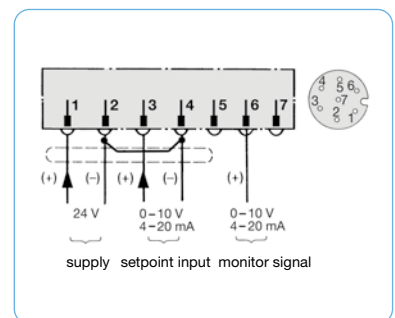
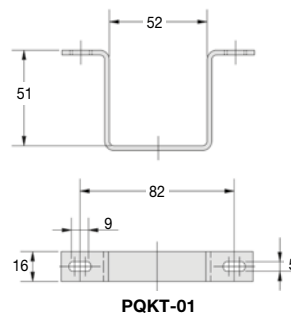
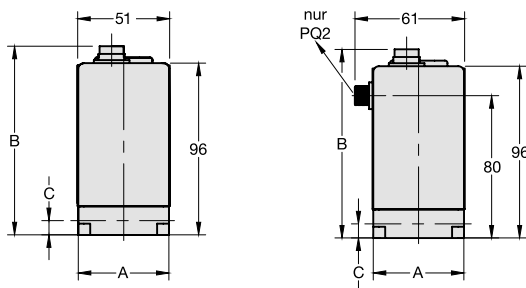

\*1 at 7 bar supply pressure and open outlet, at regulated flow rate of 3 l/min  
\*2 higher supply pressure on request  
\*3 air consumption

\* Product group

Technical details: see previous page

PDF CAD  
www.aircom.net



Order example:  
**PQ1EE-A5**

# PROPORTIONAL PRESSURE REGULATOR WITH DOUBLE LOOP, ACCURATE TO 0.2%

PQ2

<b>Description</b>	The pneumatic proportional pressure regulator produces outlet pressure in proportion to an electrical command input signal. It comprises a complete closed loop servo system consisting of valves, manifold, housing and electronic controls.
<b>Double loop</b>	The servo valve expands in single loop operation by combining an additional feedback from an external sensing device with the internal transducer. The external sensor provides information on the control status. The PQ2 then compares the command signal with the second loop feedback signal. Should there be a difference in the signal comparisons, the servo valve will make adjustments to the internal loop to bring the system into balance. This provides accurate final outlet. The acceptance of electrical feedback from an external sensor enables precise control of conditions such as pressure, force, torque, position or flow.
<b>External pressure transducer</b>	Any pressure transducer for 0-10 V and 4-20 mA output signal and suitable for 15-24V DC supply voltage can be applied. An appropriate coupling socket plus cable is required.

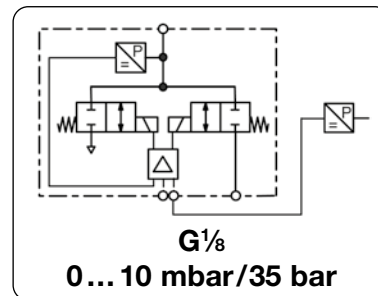

Dimensions			Flow rate	Supply pressure	Accuracy	Connection thread	Pressure range	Order number
A	B	C						
mm	mm	mm	l/min*1	max. mbar/bar*2	%	G	mbar/bar	E*

Double loop regulator				0 ... 10 V input / feedback / second loop signal, supply voltage 24 V DC, 35 l/min*1, with both coupling sockets		PQ2		
51	106	8	on request	10 mbar	0.2	G <sup>1</sup> / <sub>8</sub>	0 ... 5 mbar	PQ2EE-A5
				20 mbar			0 ... 10 mbar	PQ2EE-B1
				40 mbar			0 ... 20 mbar	PQ2EE-B2
				100 mbar			0 ... 50 mbar	PQ2EE-B5
				200 mbar			0 ... 100 mbar	PQ2EE-C1
				400 mbar			0 ... 200 mbar	PQ2EE-C2
				800 mbar			0 ... 400 mbar	PQ2EE-C4
				1000 mbar			0 ... 600 mbar	PQ2EE-C6
51	106	8	35	2 bar	0.2	G <sup>1</sup> / <sub>8</sub>	0 ... 1 bar	PQ2EE-01
				3 bar			0 ... 2 bar	PQ2EE-02
				7 bar			0 ... 4 bar	PQ2EE-04
				7 bar			0 ... 6 bar	PQ2EE-06
				9 bar			0 ... 8 bar	PQ2EE-08
				15 bar			0 ... 10 bar	PQ2EE-10
				15 bar			0 ... 12 bar	PQ2EE-12
				24 bar			0 ... 16 bar	PQ2EE-16
				24 bar			0 ... 20 bar	PQ2EE-20
				38 bar			0 ... 25 bar	PQ2EE-25
				38 bar			0 ... 30 bar	PQ2EE-30
				38 bar			0 ... 35 bar	PQ2EE-35
51	106	8	35	0 bar	0.2	G <sup>1</sup> / <sub>8</sub>	0 ... -1 bar	PQ2EE-V0
				2 bar			-1 ... +1 bar	PQ2EE-V1



## Special options, add the appropriate letter or number

4-20 mA input / feedback / second loop signal	PQ2 IC- . . .
flow 100 l/min increased flow rate, max. 10 bar	PQ2 . . . . HF
continuous regulation*3 improved characteristic curve through proportional inlet valve, max. 10 bar	PQ2 . . . . X58
declining curve inverted outlet	PQ2 . . . . X59

## Accessories, enclosed

coupling socket	M16x0.75, 7-pin with 2.0 m cable, supply and signal, straight	PRK-A2L
coupling socket	1/2" UNF, 3-pin with 0.9 m cable, for second loop, angular	PRK-C2L
coupling socket		PQH-L1
coupling socket		PQH-L2
mounting bracket	made of steel	PQKT-01

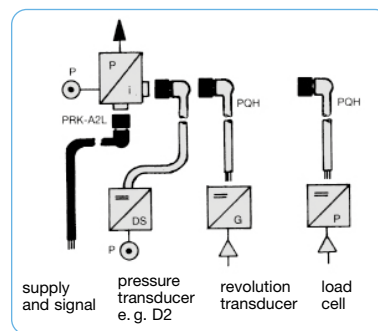
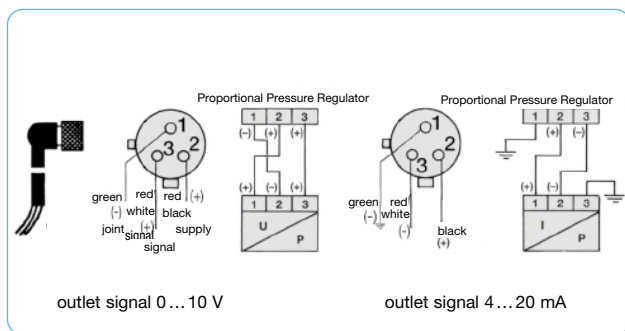

\*1 at 7 bar supply pressure and open outlet, at regulated flow rate of 3 l/min  
\*2 higher supply pressures on request      \*3 air consumption

Technical details: see previous page

PDF CAD  
www.aircom.net

\* Product group  
Order example:  
PQ2EE-A5



# PROPORTIONAL PRESSURE REGULATOR WITH HIGH ACCURACY AND HIGH FLOW PQ3...PQ6

## Technical features

• <b>Pressure range</b>	-1... 35 bar	• <b>Accuracy</b>	± 0.4%
• <b>Input signal</b>	0-10 V; 4-20 mA	• <b>Mounting position</b>	any
• <b>Protection class</b>	IP65	• <b>Adjustment</b>	zero point, span, hysteresis
• <b>Response time</b>	15 ... 20 ms	• <b>Air consumption</b>	without air consumption
• <b>Power consumption</b>	6 W		

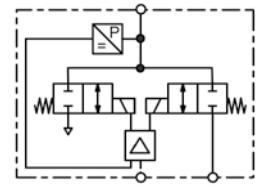

**accurate 0.4%**

## General technical features

<b>Description</b>	Two solenoid valves control the system pressure. One valve is for inlet control, the other for outlet control. In order to achieve high volume flow the regulator is pilot-controlled, i.e. the valves control an integral volume booster. Extraordinary accuracy is reached by measuring the outlet pressure of the booster and feeding back the according signal.		
<b>Mounting position</b>	any, preferably upright		
<b>Protection class</b>	IP65		
<b>Temperature range</b>	0 °C to 70 °C / 32 °F to 158 °F		
<b>Material</b>	Booster body: nickel-plated aluminium	Elastomer: FKM, NBR/Buna-N	
	Transducer: aluminium and silicon	Valves: nickel-plated brass	

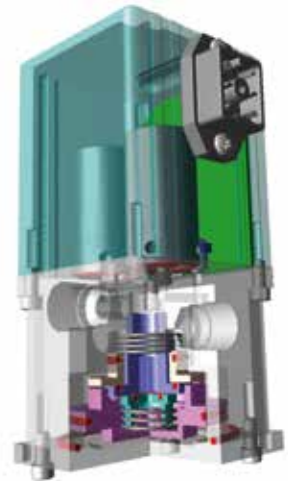

## Pneumatic features

<b>Media</b>	dry, unlubricated and 40 µm filtered compressed air or non-corrosive gases
<b>Supply pressure</b>	see chart, minimum 10% above outlet pressure
<b>Flow rate</b>	<b>PQ3:</b> 700 l/min at 8 bar supply pressure and 6 bar outlet pressure <b>PQ4 / PQ6:</b> 2000 l/min at 8 bar supply pressure and 6 bar outlet pressure
<b>Exhaust</b>	nearly same relief capacity as ventilation capacity
<b>Air consumption</b>	without constant bleed

## Electrical features

<b>Supply voltage</b>	15-24 V DC
<b>Power consumption</b>	max. 6 W
<b>Command signal</b>	0-10 V, optionally 4-20 mA
<b>Command signal impedance</b>	10 kΩ at voltage signal, 100 Ω at current signal
<b>Electrical connector</b>	plug M16x0.75, 7-pin, with coupling socket
<b>Monitor signal</b>	0-10 V, optionally 4-20 mA
<b>Security</b>	constant outlet pressure at voltage drop

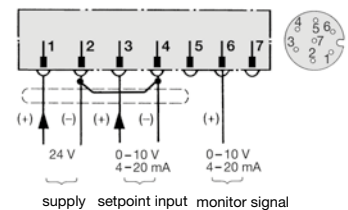

connection diagram for supply and signal

## Accuracy

<b>Linearity / Hysteresis</b>	± 0.3% FS > 7 bar outlet pressure ± 0,5% FS
<b>Response sensitivity</b>	< 0.1% FS
<b>Response time</b>	10 ... 15 ms
<b>Repeatability</b>	± 0.2% FS
<b>Accuracy</b>	± 0.4% FS

## Adjustment

<b>Adjustment</b>	Adjustment by calibration access cap on the top of the valve.
<b>Zero point</b>	The zero point can be changed by up to 10% of full scale, e.g. from 0 bar to 0.6 bar at a 6 bar regulator. External adjustment via potentiometer Z "zero".
<b>Span</b>	The maximum pressure value of the control range can be reduced by up to 10%, e.g. from 6 bar to 5.4 bar. External adjustment via potentiometer S "span".
<b>Hysteresis</b>	Response sensitivity can be adjusted via potentiometer H "hysteresis".

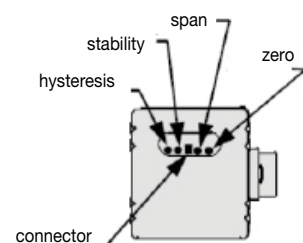
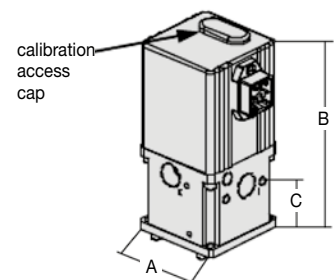

# PROPORTIONAL PRESSURE REGULATOR WITH HIGH ACCURACY AND HIGH FLOW PQ3...PQ6

## Description

Closed loop electronic pressure regulator consisting of two solenoid valves, an internal pressure transducer, and an electronic control circuit mounted to an integral volume booster. The pressure is controlled by activating the solenoid valves, which apply pressure to the pilot side of the volume booster.

## Single loop

Pressure is controlled by two solenoid valves. One valve functions as inlet control, the other as exhaust. The pressure outlet is measured by an internal pressure transducer which provides a feedback signal to the electronic controls. This feedback signal is compared with the command input signal. Any difference between the two signals causes one of the two solenoid valves to open, allowing flow into or out of the system. Accurate pressure is maintained by these two valves.

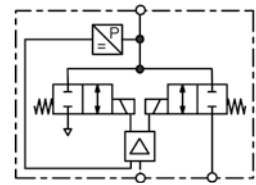

0...0.1 bar/35 bar

Dimensions			Flow rate l/min*1	Supply pressure max. bar	Accuracy %	Connection thread G/NPT	Pressure range bar	Order number	E*
A	B	C							
mm	mm	mm							

## Single loop regulator

0 ... 10 V input and feedback signal  
supply voltage 24 V DC, with coupling socket

## PQ3/PQ4/PQ6

51	123	34	700	1	0,25	1/4" NPT	0...0,1	PQ3EE-C1	
				1			0...0,5	PQ3EE-C5	
				2			0...1,0	PQ3EE-01	
				3			0...2,0	PQ3EE-02	
				7			0...4,0	PQ3EE-04	
				7			0...6,0	PQ3EE-06	
				9			0...8,0	PQ3EE-08	
				15			0...10	PQ3EE-10	
				15			3/8" NPT	0...12	PQ3EE-12
				24				0...16	PQ3EE-16
				24				0...20	PQ3EE-20
				38				0...25	PQ3EE-25
77	175	65	2000	1	0,4	1/2" NPT	0...0,1	PQ4EE-C1	
				1			0...0,5	PQ4EE-C5	
				2			0...1,0	PQ4EE-01	
				3			0...2,0	PQ4EE-02	
				7			0...4,0	PQ4EE-04	
				7			0...6,0	PQ4EE-06	
77	175	65	2000	1	0,4	3/4" NPT	0...0,1	PQ6EE-C1	
				1			0...0,5	PQ6EE-C5	
				2			0...1,0	PQ6EE-01	
				3			0...2,0	PQ6EE-02	
				7			0...4,0	PQ6EE-04	
				7			0...6,0	PQ6EE-06	
9	0...8,0	PQ6EE-08							
15	0...10	PQ6EE-10							



PQ3EE-10



PQ4EE-10

## Special options, add the appropriate letter

4-20 mA input and monitor signal PQ . IC- . .

## Accessories, enclosed

coupling socket	M16x0.75, 7-pin with 2 m cable	straight	PRK-A2L
mounting bracket	made of steel	angular	PRK-C2L
mounting bracket	made of steel	for PQ3	PQKT-01
		for PQ4/PQ6	PQKT-02



PRK-A

PRK-C

\*1 at 8 bar inlet pressure and 6 bar outlet pressure

Technical details: see previous page

PDF CAD  
www.aircom.net

\* Product group



Order example:  
PQ3EE-C1

<b>Description</b>	<p>The pneumatic proportional pressure regulator controls the outlet pressure in proportion to an electrical command input signal. It comprises a complete closed loop servo system in a compact monoblock assembly with proportional solenoid valve, electronic regulator and internal pressure transducer.</p> <p>In the process, the outlet pressure is transformed into a proportional electrical signal and compared with the input signal. If the outlet pressure exceeds the preset setpoint, the valve exhausts down to the pressure desired.</p> <p>The valve has no constant bleed. At absence of input signal or supply voltage the valve exhausts. The power supply of the setpoint potentiometer is provided by the proportional regulator via connector pin number 5.</p>
<b>Pressure transducer</b>	Open transducers: 100 mbar, 500 mbar, 1/5/10/16/20/30/50 bar and vacuum
<b>Application examples</b>	Proportional pressure regulators are being used for blowing machines, ultrasonic equipments, testing machines, painting systems, contouring systems, laser welding machines, textile machines, cheese presses, pneumatic brakes, clamping devices and medical engineering.

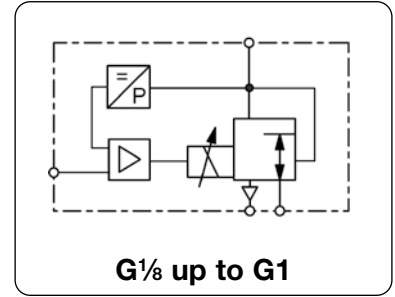

## General technical features

<b>Description</b>	3-port/2-way pressure regulator with proportional magnet, integrated hybrid PCB and closed loop with pressure transducer in compact monoblock assembly.
<b>Mounting position</b>	any, preferably upright
<b>Protection class</b>	IP 54 with standard connector, IP 65 with special connector
<b>Shock resistance</b>	3G
<b>Temperature range</b>	0 °C up to 50 °C / 32 °F to 122 °F, high temperature version on request
<b>Material</b>	Body: brass (G <sup>1</sup> / <sub>8</sub> ) and aluminium (G <sup>1</sup> / <sub>4</sub> , G <sup>1</sup> / <sub>2</sub> u. G1) Inner valve: brass and SST Seals: NBR/Buna-N, on request EPDM or FKM FKM for 50 bar version

## Pneumatic features

<b>Media</b>	dry, lubricated, unlubricated and 50 µm filtered compressed air or non-corrosive gases
<b>Supply pressure</b>	see chart, min. 10% above outlet pressure
<b>Flow rate</b>	see chart, at 6 bar inlet pressure and 5 bar outlet pressure
<b>Exhaust</b>	same nominal size as on inlet valve, thus same relief capacity
<b>Air consumption</b>	without air consumption

## Electrical features

<b>Supply voltage</b>	24 V DC + 15% - 10%, residual ripple max. 10%
<b>Power consumption</b>	12 W at G <sup>1</sup> / <sub>8</sub> , 22 W at G <sup>1</sup> / <sub>4</sub> , 30 W at G <sup>1</sup> / <sub>2</sub> , 44 W at G1
<b>Current consumption</b>	0.5A at G <sup>1</sup> / <sub>8</sub> , 1.0A at G <sup>1</sup> / <sub>4</sub> , 1.25A at G <sup>1</sup> / <sub>2</sub> , 1.7A at G1
<b>Command signal</b>	0 ... 10 V, 0 ... 20 mA, 4 ... 20 mA, digital or Profibus DB rising curve as standard, optionally declining curve
<b>Impedance</b>	100 kΩ at voltage signal (0.1 mA current consumption) 500 Ω at current signal
<b>Electrical connector</b>	circular plug according to DIN 43651, 7-pin plug for analogue signal 16-pin plug for digital signal

## Accuracy

<b>Linearity/Hysteresis</b>	< 1% FS
<b>Response sensitivity</b>	< 0.1% FS
<b>Repeatability</b>	< 0.1% FS
<b>Over all accuracy</b>	± 0.5%
<b>Regulating time</b>	< 1 s over the range, 70 ms at 10 to 90% or 90 to 10% of the range

## Adjustment

<b>Zero point</b>	calibration ± 10% FS via potentiometer P2
<b>Range</b>	calibration + 5% FS or -10% FS via potentiometer P1
<b>Amplification</b>	calibration 1:1 up to 1:10 via potentiometer P7

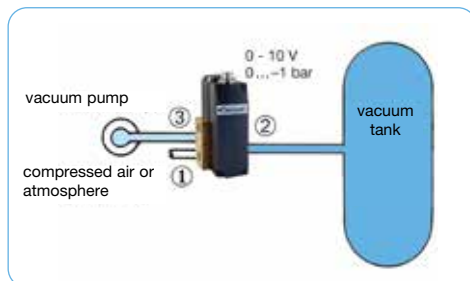

### Downstream regulation (V1)

The vacuum pump saves energy and it is easy to fill the tank either with vacuum or pressure. A filter is recommended at orifice ①.

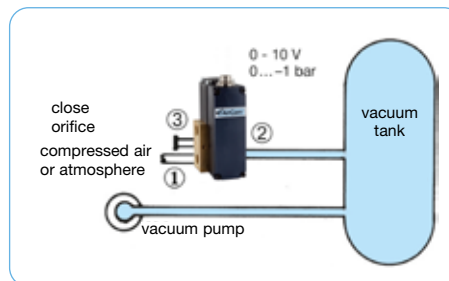

### Upstream regulation (V2)

Upstream installation is preferred if rapid evacuation of a tank or system is required. A filter is recommended at orifice ①.

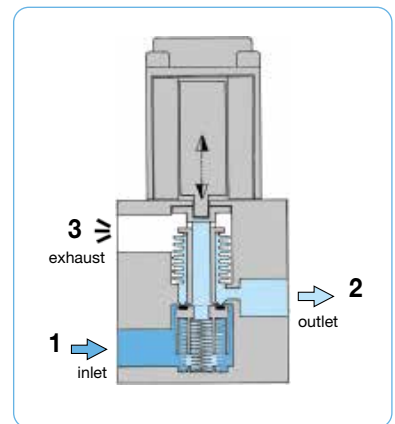
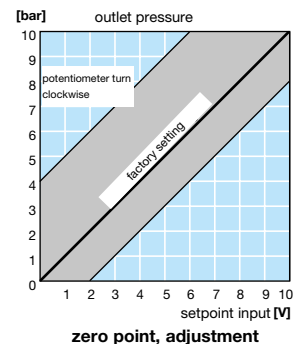
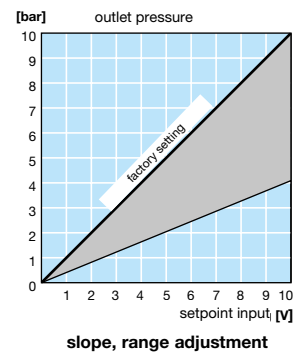
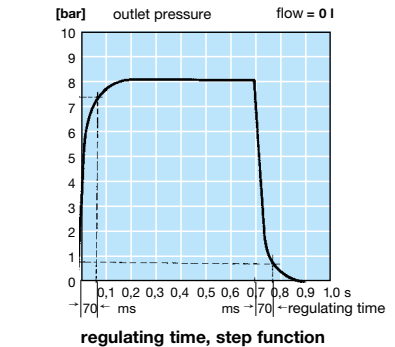



Technical features

- **Pressure range** 0...-1.0 bar to 0...50 bar
- **Command signal** 0...10 V, 0...20 mA, 4...20 mA, digital
- **Feedback signal** 0...10 V, 0...20 mA, 4...20 mA
- **Adjustment** zero point, range and amplification
- **Pressure sensors** 100 / 500 mbar, 1/5/10/16/20/30/50 bar
- **Flow rate** 250 / 820 / 1700 / 6500 l/min
- **Linearity / Hysteresis** < 1% FS
- **Response sensitivity** ± 0,5% FS
- **Repeatability** ± 0,5% FS
- **Regulating time** < 1 s
- **Power consumption** 12 / 22 / 30 / 44 W
- **Exhaust** full nominal size

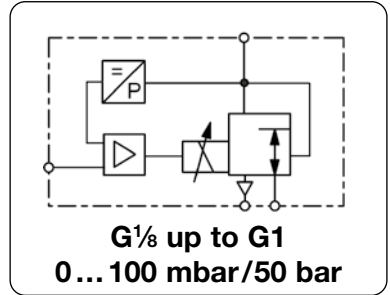

Dimensions			Nominal size	K <sub>v</sub> -value	Flow rate	Supply max.	Connection thread	Pressure range	Order number
A	B	C	DN	(m³/h)	l/min*1	bar	G	bar	

**Proportional pressure regulator** 0-10 V input signal, supply voltage 24 V DC, with coupling socket **PR**

35	80	63	3	0.18	210	-1	G1/8	0...-1.0	PRA00-00V1
						-1		0...-0.5	PRA00-00V1A5
						-1		0...-0.1	PRA00-00V1A1
						3		-1,0... 1.0	PRA00-01V1
						1		0... 0.1	PRA00-A100
						2		0... 0.5	PRA00-A500
						2		0... 1.0	PRA00-0100
						12		0... 6.0	PRA00-0600
						12		0... 10	PRA00-1000
						22		0... 20	PRA00-2000
52	105	74	6	0.6	700	-1	G1/4	0...-1.0	PR000-00V1
						-1		0...-0.5	PR000-00V1A5
						-1		0...-0.1	PR000-00V1A1
						3		-1,0... 1.0	PR000-01V1
						1		0... 0.1	PR000-A100
						2		0... 0.5	PR000-A500
						2		0... 1.0	PR000-0100
						12		0... 6.0	PR000-0600
						12		0... 10	PR000-1000
						18		0... 16	PR000-1600
						22		0... 20	PR000-2000
						40		0... 30	PR000-3000
						60		0... 50	PR000-5000
70	150	101	12	1.2	1400	-1	G1/2	0...-1.0	PR100-00V1
						2		0... 1.0	PR100-0100
						12		0... 6.0	PR100-0600
						12		0... 10	PR100-1000
						14		0... 12	PR100-1200
96	190	115	20	4.8	5600	-1	G1	0...-1.0	PR200-00V1
						2		0... 1.0	PR200-0100
						12		0... 6.0	PR200-0600
						12		0... 10	PR200-1000
						14		0... 12	PR200-1200



PRA



PR000



PR100



PR200

\*1 at 6 bar supply pressure and 5 bar outlet pressure

Technical details: see previous page

PDF CAD  
www.aircom.net

\* Product group



Order example:  
PRA00-00V1

### Technical features

• <b>Pressure range</b>	0...-1.0 bar to 0...50 bar	• <b>Linearity / Hysteresis</b>	< 1% FS
• <b>Command signal</b>	0...10 V, 0...20 mA, 4...20 mA, digital	• <b>Response sensitivity</b>	± 0,5% FS
• <b>Feedback signal</b>	0...10 V, 0...20 mA, 4...20 mA	• <b>Repeatability</b>	± 0,5% FS
• <b>Adjustment</b>	zero point, range and amplification	• <b>Regulating time</b>	< 1 s
• <b>Pressure sensors</b>	100 / 500 mbar, 1/5/10/16/20/30/50 bar	• <b>Power consumption</b>	12 / 22 / 30 / 44 W
• <b>Flow rate</b>	250 / 820 / 1700 / 6500 l/min	• <b>Exhaust</b>	full nominal size

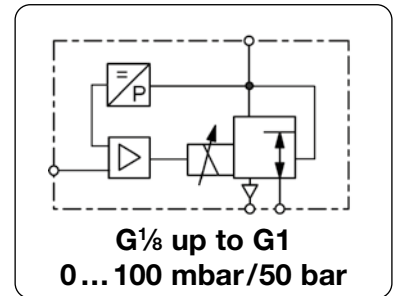

### Special options, add the appropriate letter or number

<b>input signal</b>	0-20 mA		PR ..1-....
	4-20 mA		PR ..2-....
	8 bit digital with hold function		PR ..3-....
	Profibus DP	from G <sup>1</sup> / <sub>4</sub> on	PR ..8-....
<b>feedback signal</b>	0-10 V		PR .1.-....
	0-20 mA		PR .2.-....
	4-20 mA		PR .3.-....
<b>external feedback signal</b>	0-10 V		PR .4.-....
	0-20 mA		PR .5.-....
	4-20 mA		PR .6.-....
<b>deviant pressure range</b>	indicate on order		PR ...-XX. .
<b>for vacuum</b>	Bypass version	G <sup>1</sup> / <sub>8</sub> and G <sup>1</sup> / <sub>4</sub>	PR ...-..V2
		G <sup>1</sup> / <sub>2</sub>	PR1. ....V2
		G1	PR2. ....V2
<b>for absolute pressure</b>			PR ...-..0A
<b>protection class IP65</b>	special cable box, PRK-IP65		PR ...-..06
<b>body made of stainless steel</b>	valve body and inner parts , 1.4304, EPDM seals, G <sup>1</sup> / <sub>4</sub> and G <sup>1</sup> / <sub>2</sub>		PR ...-..SS
<b>body made of aluminium</b>	nly valve body, max. 20 bar	G <sup>1</sup> / <sub>4</sub> only	PR ...-..19
<b>for oxygen</b>	specially cleaned, FKM elastomer		PR ...-..15



example: combination PR with booster

### Accessories, enclosed

<b>coupling socket</b>	7-pin with 2 m cable	straight	<b>PRK-A2L</b>
	7-pin with 5 m cable	straight	<b>PRK-A5L</b>
	7-pin with 2 m cable, IP65	straight	<b>PRK-I 2L</b>
	7-pin with 2 m cable	angular	<b>PRK-C2L</b>
	7-pin with 5 m cable	angular	<b>PRK-C5L</b>
<b>other cable length</b>	e.g. 10 m available		



PRK-A

PRK-C



# DIMENSIONS AND CONNECTION DIAGRAM "AIRTRONIC"®

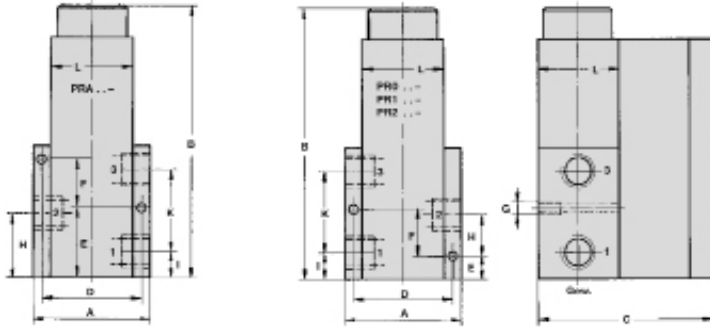

1: inlet  
2: outlet  
3: exhaust

Proport. regulator	thread	A	B	C	D	E
PRA . . .	G ½	35	80	63	29	18
PR0 . . .	G ¼	52	105	74	43	10
PR1 . . .	G ½	70	150	101	57.5	12
PR2 . . .	G 1	96	190	115	79	15

Proport. regulator	F	G	H	I	K	L
PRA . . .	7	M 4	15	10	16.6	25
PR0 . . .	20	M 4	16	11*	34	36
PR1 . . .	28	M 6	23	15	48.5	45
PR2 . . .	33	M 8	30	20	60	60

\* 14 mm from 30 bar pressure range on

## "AIRTRONIC"® PROPORTIONAL PRESSURE REGULATOR WITH INTEGRATED PCB

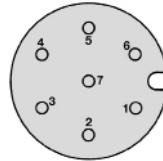
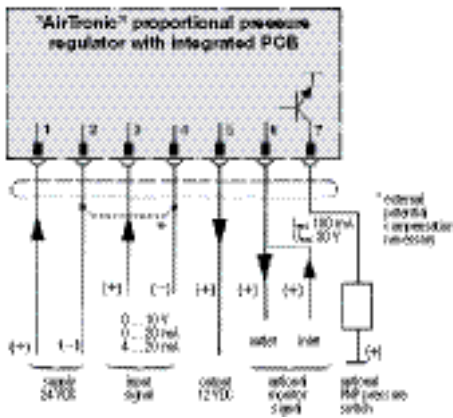

pin	colour of wire	
	4-wire	7-wire
1	white	grey
2	brown	blue
3	yellow	yellow
4	green	green
5	-	brown
6	-	white
7	-	pink

pin numbers seen from solder pin side

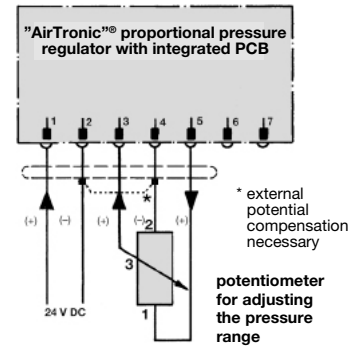

## "AIRTRONIC"® CONNECTION DIAGRAM

## CONNECTION DIAGRAM WITH POTENTIOMETER

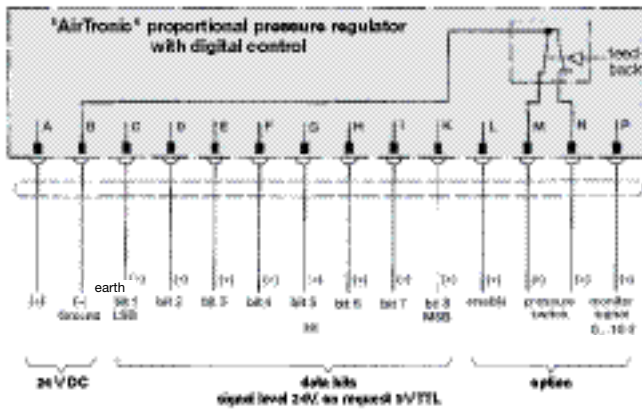

## CONNECTION DIAGRAM FOR DIGITALLY CONTROLLED PROPORTIONAL PRESSURE REGULATOR

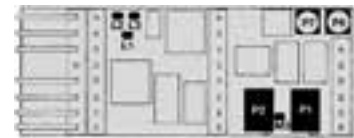

- P1 range: -10%...+5%
- P2 zero point: ± 10%
- P6 option pressure switch: 5...15%
- P7 proportional amplification: 1...11
- M3 measuring point offset zero
- L1 earth (GND)
- L2 solenoid +24 V
- L3 solenoid (pulse width modulation) PWM

## ADJUSTMENT OF THE PROPORTIONAL REGULATOR

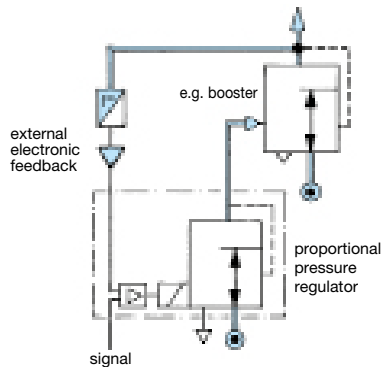

### EXTERNAL ELECTRONIC FEEDBACK

0 ... 10 V or 0/4 ... 20 mA

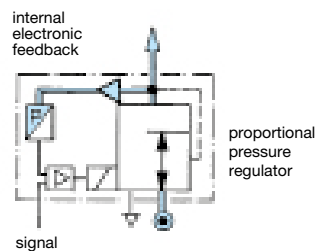

### INTERNAL ELECTRONIC FEEDBACK

as standard

<b>Description</b>	The pneumatic proportional regulator controls the outlet pressure in proportion to an electrical command input signal. It comprises a complete closed loop servo system in a compact mono block assembly with proportional solenoid valve, electronic regulator and internal pressure transducer. The valve works as a slide valve and is designed for flow applications such as thermal cutting. The digital control system offers advantages at installation and commissioning for adapting the valve to special applications. The regulator can be set and optimised using a PC, PR adapter and software. Data record can be saved and used for further valves. The valve has a constant bleed. At absence of input signal or supply voltage the valve exhausts.		
<b>Software</b>	Display: signal, outlet pressure, PID parameters, pressure switch signal etc.		
<b>Scope function</b>	view setpoint, outlet pressure, internal signals from PID control		
<b>Media</b>	dry, lubricated, unlubricated and 50 µm filtered compressed air or non-corrosive gases		
<b>Supply voltage</b>	24 V DC ± 10 V, residual ripple < 10%	<b>Power consumption</b>	14 W (810mA current consumption)
<b>Signal range</b>	0-10 V, 100 kΩ impedance	0/4-20 mA, 250 Ω impedance	
<b>Electr. connection</b>	plug M12x1, 5-pin (protection class IP65)	<b>Mounting position</b>	any, preferably solenoid on top
<b>Accuracy</b>	hysteresis: 0.5% FS	<b>Linearity/repeatability</b>	< ± 0.5% FS
<b>Temp. range</b>	fluid / ambient: 0 °C to 60 °C / 32 °F to 140 °F	<b>Material</b>	Body: aluminium Elastomer: NBR/Buna-N

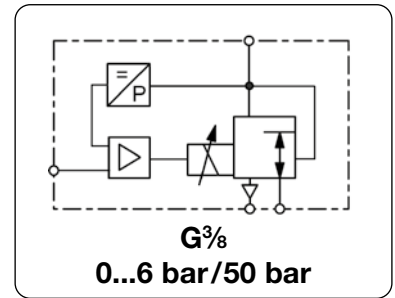

Dimensions			Nominal size	K <sub>v</sub> -value	Flow rate	Supply max.	Connection thread	Pressure range	Order number	E*
A	B	C	DN	(m <sup>3</sup> /h)	l/min*1	bar	G	bar		

Proportional pressure regulator										0-10 V command signal, supply voltage 24 V DC, without M12 coupling socket	PF
60	160	78	8	1,45	1700	12	G <sup>3</sup> / <sub>8</sub>	0 ... 6	PF000-0600		
						18		0 ... 10	PF000-1000		
						18		0 ... 16	PF000-1600		
						22		0 ... 20	PF000-2000		
						40		0 ... 30	PF000-3000		
						50		0 ... 40	PF000-4000		
						60		0 ... 50	PF000-5000		



### Special options, add the appropriate letter or number

<b>command signal</b>	0-20 mA	PF..1-....
	4-20 mA	PF..2-....
<b>monitor signal</b>	0-10 V	PF.1.-....
	4-20 mA	PF.3.-....
<b>deviant pressure range</b>	indicate on order	PF...-XX..
<b>for oxygen</b>	specialy cleaned, FKM elastomers	PF...-...15

### Accessories, enclosed

<b>PR adapter</b>	with USB plug and 1 m cable	<b>PDUSB</b>
<b>software</b>	basic version "light"	<b>PDSOFT1<sup>2</sup></b>
<b>coupling socket</b>	M12x1, 5-pin, with 2 m cable, 5 x 0.25	angular <b>KM12-C5-2</b>
	M12x1, 5-pin, with 5 m cable, 6 x 0.25	angular <b>KM12-C5-5</b>

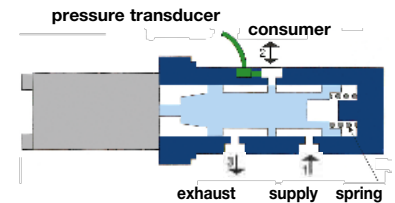

The position of the slide is continuously shifting according to command signal and pressure change at the outlet. Thereby a constant outlet pressure is achieved.

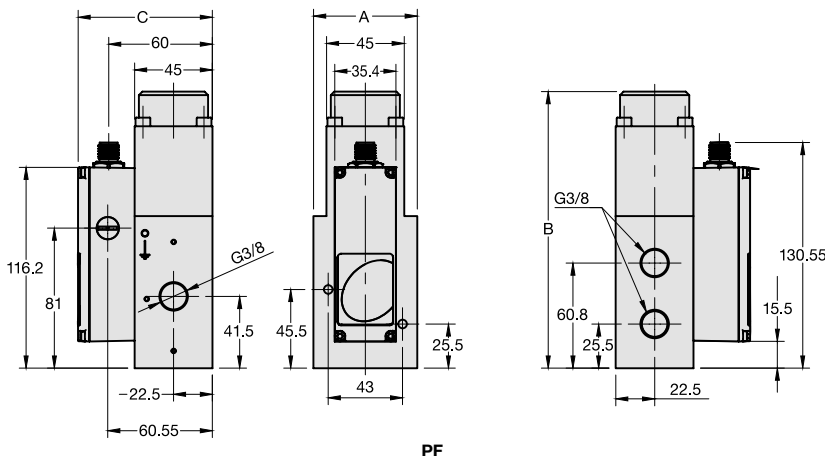

\*1 at 6 bar supply pressure and 5 bar outlet pressure  
\*2 You do not need any software to use the valve!

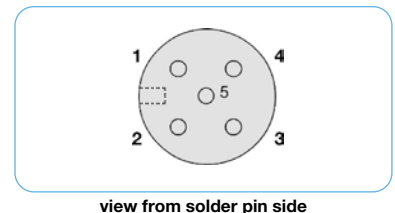

pin	description	5-wire cable (2m)
1	24 V supply voltage	brown
2	analog input signal	white
3	supply ground	blue
4	analog ground	black
5	digital pressure switch signal	grey
housing	EMC shield	shield

connection diagram

\* Product group

PDF CAD  
www.aircom.net



Order example:  
PF000-0600

<b>Description</b>	The pneumatic proportional regulator controls the outlet pressure in proportion to an electrical command input signal. It comprises a complete closed loop servo system in a compact mono block assembly with proportional solenoid valve, electronic regulator and internal pressure transducer. The valve works as a 3-port/2-way valve with proportional magnet. The digital control system offers advantages at installation and commissioning for adapting the valve to special applications. The regulator can be set and optimised using a PC, PR adapter and software. Data record can be saved and used for further valves. The valve has no constant bleed. At absence of input signal or supply voltage the valve exhausts.
<b>Software</b>	Display: signal, outlet pressure, parameter, pressure switch signal etc. Scope function: view setpoint, outlet pressure, internal signals from PID control Parameters: command signal, zero point, overload threshold, ramp Valve diagnosis: parameters factory set or customised, optimization of the valve

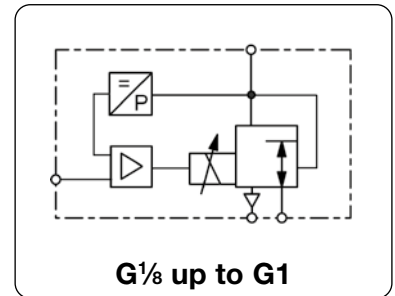

## General technical features

<b>Description</b>	3-port/2-way valve with proportional magnet and digital control
<b>Mounting position</b>	any, preferably vertical
<b>Protection class</b>	IP65 with mounted coupling socket
<b>Shock resistance</b>	3G
<b>Temperature range</b>	0 °C to 60 °C / 32 °F to 140 °F, fluid / ambient temperature
<b>Material</b>	Body: brass (for G <sup>1</sup> / <sub>8</sub> and G <sup>1</sup> / <sub>4</sub> ) or aluminium (for G <sup>1</sup> / <sub>2</sub> and G1) Inner valve: brass and stainless steel Seals: NBR/Buna-N, EPDM or FKM on request, FKM for 50 bar version

## Pneumatic features

<b>Media</b>	dry, lubricated, unlubricated and 5 µm filtered compressed air or non-corrosive gases
<b>Supply pressure</b>	see chart
<b>Flow rate</b>	see chart, at 6 bar supply pressure and 5 bar outlet pressure
<b>Exhaust</b>	same nominal size as on inlet valve, thus same relief capacity without air consumption
<b>Air consumption</b>	

## Electrical features

<b>Supply voltage</b>	24 V DC ±10%
<b>Electrical connection</b>	M12, 5-pin coupling socket
<b>Power consumption</b>	12 W at G <sup>1</sup> / <sub>8</sub> , 24 W at G <sup>1</sup> / <sub>4</sub> , 34 W at G <sup>1</sup> / <sub>2</sub> , 44 W at G1
<b>Current consumption</b>	500 mA at G <sup>1</sup> / <sub>8</sub> , 1000 mA at G <sup>1</sup> / <sub>4</sub> , 1400 mA at G <sup>1</sup> / <sub>2</sub> , 1800 mA at G1
<b>Command signal</b>	0-10 V, 0-20 mA, 4-20 mA
<b>Impedance</b>	100 kΩ at voltage signal (0.1 mA current consumption) 250 Ω at current signal
<b>Setpoint input</b>	0-10 V, 0-20 mA, 4-20 mA

## Accuracy

<b>Linearity</b>	< ± 0.5% FS
<b>Hysteresis</b>	< ± 1.0% FS
<b>Repeatability</b>	± 0.5% FS
<b>Response sensitivity</b>	± 1.0% FS

## Adjustment and parameter settings

<b>Zero point / range</b>	Zero point and range can be calibrated percentagewise.
<b>Control mode / Amplification</b>	Through the software different control modes may be chosen. All parameters of P/PI/PID controllers can be tuned.
<b>Diagnosis</b>	A diagnostic tool including data recording is available within the software.
<b>Characteristic curve</b>	Increasing or decreasing curve can be set (increasing by standard).

### Downstream regulation for vacuum/positive pressure regulators (V1)

Recommended when tank shall be evacuated or filled with positive pressure. At inlet port (1) either compressed air or atmosphere has to be applied. The use of a filter is advisable.

### Downstream regulation for vacuum regulators (V3)

Recommended when tank shall be evacuated. Exhaust port (3) will be closed. Inlet port (1) must be connected with vacuum pump. Outlet port (2) has to be connected with consumer or tank.

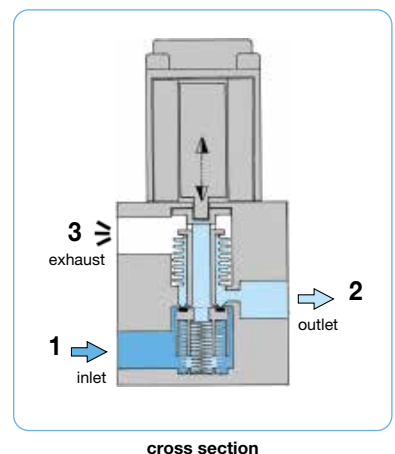
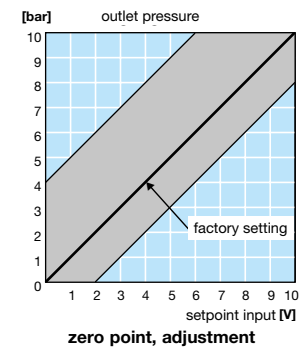
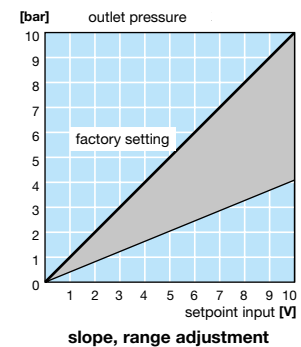
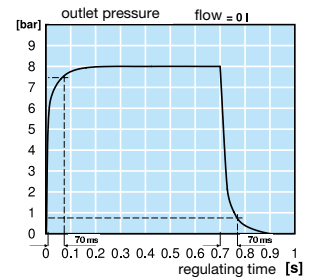



### Technical features

• <b>Pressure range</b>	0...0.1 bar bis 0...50 bar	• <b>Linearity</b>	< ± 0.5% FS
• <b>Command signal</b>	0-10 V, 0-20 mA, 4-20 mA	• <b>Hysteresis</b>	< ± 1.0% FS
• <b>Output signal</b>	0-10 V, 0-20 mA, 4-20 mA	• <b>Response sensitivity</b>	± 1.0% FS
• <b>Regulating time</b>	< 1 s	• <b>Repeatability</b>	± 0.5% FS
• <b>Pressure sensor</b>	100 / 500 mbar, 1 / 5 / 10 / 16 / 20 / 30 / 50 bar	• <b>Rated input</b>	12 / 22 / 30 / 44 W
• <b>Flow rate</b>	250 / 820 / 1700 / 6500 l/min	• <b>Relief capacity</b>	full nominal size

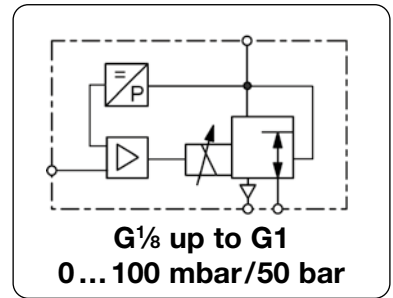

Dimensions			Nominal size	K <sub>v</sub> -value	Flow rate	Supply max.	Connection thread	Pressure range	Order number
A	B	C	DN	(m <sup>3</sup> /h)	l/min*1	bar	G	bar	

Proportional pressure regulator									
0-10 V command signal, supply voltage 24 V DC, with coupling socket									
35	83	57	3	0.18	210	-1	G <sup>1</sup> / <sub>8</sub>	0...-1.0	<b>PPA00-00V3</b>
						2		0... 0.1	<b>PPA00-A100</b>
						2		0... 0.5	<b>PPA00-A500</b>
						2		0... 1.0	<b>PPA00-0100</b>
						8		0... 3.0	<b>PPA00-0300</b>
						12		0... 6.0	<b>PPA00-0600</b>
						12		0... 10	<b>PPA00-1000</b>
						18		0... 16	<b>PPA00-1600</b>
						22		0... 20	<b>PPA00-2000</b>
						30		0... 25	<b>PPA00-2500</b>
52	105	68	6	0.6	700	-1	G <sup>1</sup> / <sub>4</sub>	0...-1.0	<b>PP000-00V3</b>
						2		0... 0.1	<b>PP000-A100</b>
						2		0... 0.5	<b>PP000-A500</b>
						2		0... 1.0	<b>PP000-0100</b>
						8		0... 3.0	<b>PP000-0300</b>
						12		0... 6.0	<b>PP000-0600</b>
						12		0... 10	<b>PP000-1000</b>
						18		0... 16	<b>PP000-1600</b>
						22		0... 20	<b>PP000-2000</b>
						40		0... 30	<b>PP000-3000</b>
						60		0... 50	<b>PP000-5000</b>
70	136	85	12	1.2	1400	-1	G <sup>1</sup> / <sub>2</sub>	0...-1.0	<b>PP100-00V3</b>
						2		0... 1.0	<b>PP100-0100</b>
						8		0... 3.0	<b>PP100-0300</b>
						12		0... 6.0	<b>PP100-0600</b>
						12		0... 10	<b>PP100-1000</b>
						14		0... 12	<b>PP100-1200</b>
96	190	101	20	4.8	5600	-1	G1	0...-1.0	<b>PP200-00V3</b>
						2		0... 1.0	<b>PP200-0100</b>
						8		0... 3.0	<b>PP200-0300</b>
						12		0... 6.0	<b>PP200-0600</b>
						12		0... 10	<b>PP200-1000</b>
						14		0... 12	<b>PP200-1200</b>

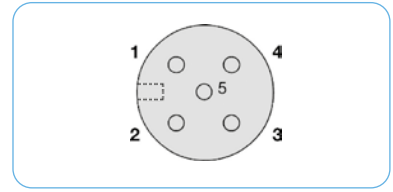
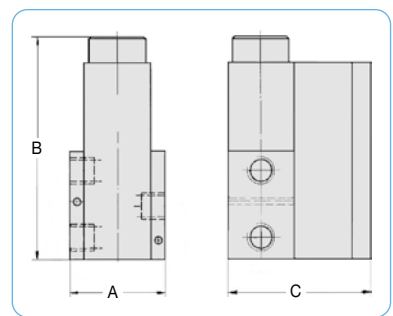

### Special options, add the appropriate letter or number

<b>setpoint input</b>	0-20 mA	<b>1</b>		4-20 mA	PP..2-....	
<b>feedback output</b>	0-10 V	<b>1</b>	0-20 mA	<b>2</b>	4-20 mA	PP..3-....
<b>deviant pressure range for absolute pressure</b>	indicate on order				PP...-XX..	
<b>body made of stainless steel</b>	P <sub>2</sub> = max. 20 bar, body / inner parts, 1.4304, EPDM, G <sup>1</sup> / <sub>4</sub> and G <sup>1</sup> / <sub>2</sub>				PP...-..0A	
<b>body made of aluminium</b>	valve body only, max. 20 bar G <sup>1</sup> / <sub>4</sub> only				PP...-..SS	
<b>for oxygen</b>	specially cleaned, FKM elastomer				PP0...-..19	
<b>cascade regulation</b>	w/o monitor signal 2. sensor, electr. feedback 0-10 V				PP...-..15	
	w/o monitor signal 2. sensor, electr. feedback 4-20 mA				PP...-..KU	
					PP...-..KI	

### Accessories, enclosed

<b>PR adapter software</b>	with USB plug and 1 m cable	<b>PDU5B</b>
<b>coupling socket</b>	basic version "light"	<b>PDSOFT1<sup>2</sup></b>
<b>adapter cable</b>	M12x1, 5-pin with 2 m cable, 5 x 0.25 angular	<b>KM12-C5-2</b>
	5 m cable, 5 x 0.25 angular	<b>KM12-C5-5</b>
	M12x1, 5-pin with 0.2 m cable	<b>PRK-PR-PP</b>

\*1 at 6 bar supply pressure and 5 bar outlet pressure  
\*2 You do not need any software to use the valve!

Technical details: see previous page [www.aircom.net](http://www.aircom.net)

pin	description	5-wire cable (2m)
1	24 V supply voltage	brown
2	analog input signal	white
3	supply earth	blue
4	analog earth	
4	analog outlet signal	black
5	digital pressure switch signal	grey
housing	EMC shield	shield

connection diagram

\* Product group

**Order example: PPA00-00V3**

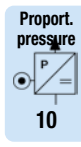

<b>Description</b>	The proportional pressure regulator is digitally controlled and works as a 3/2 valve with proportional magnet and closed loop. The digital control system offers advantages at installation and commissioning for adapting the valve to special applications. The regulator can be set and optimised using a PC, PR adapter and software.
<b>Software</b>	Display: signal, outlet pressure, PID parameters, pressure switch signal etc. Scope function: view setpoint, outlet pressure, internal signals from PID control
<b>Parameters</b>	command signal, zero point, overload threshold, ramp Valve diagnosis: parameters factory-set or customised, optimization of the valve.

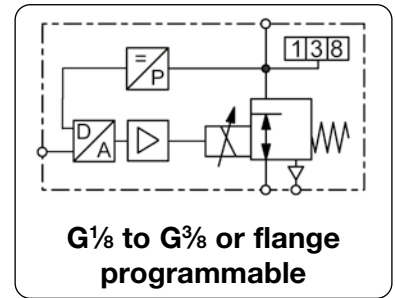

## General technical features

<b>Description</b>	3-port/2-way valve with proportional magnet and digital control
<b>Mounting position</b>	any, preferably upright
<b>Protection class</b>	IP65 with mounted coupling socket
<b>Temperature range</b>	0 °C to 50 °C / 32 °F to 122 °F ambient
<b>Material</b>	Body: aluminium Inner valve: POM (Polyacetal) Elastomer: NBR/Buna N and FPM

## Pneumatic features

<b>Media</b>	dry, lubricated or unlubricated and 50 µm filtered compressed air or non-corrosive gases
<b>Supply pressure</b>	see chart
<b>Flow rate</b>	see chart, at 7 bar supply pressure and open outlet
<b>Exhaust</b>	same nominal size as on inlet valve, thus same relief capacity
<b>Air consumption</b>	without air consumption

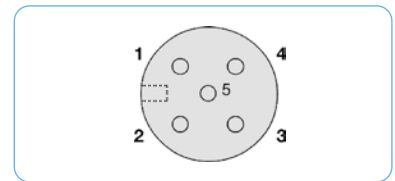

## Electrical features

<b>Supply voltage</b>	24 V DC ± 10%
<b>Electrical connection</b>	M12x1, 5-pin plug, with coupling socket
<b>Power consumption</b>	12 W at nominal size 4, 40 W at nominal size 8
<b>Current consumption</b>	850 mA at nominal size 4, 1640 mA at nominal size 8
<b>Command signal</b>	0-10 V, 0-20 mA, 4-20 mA
<b>Impedance</b>	100 kΩ at voltage signal (0.1 mA current consumption) 500 Ω at current signal
<b>Feedback output</b>	0-10 V = 3 bar only, 6 bar and 10 bar pressure range possible

pin	description	5-wire cable (2m)
1	24 V supply voltage	brown
2	analog input signal	white
3	supply ground	blue
	analog ground	
4	analog outlet signal	black
5	digital pressure switch signal	grey
housing	EMC shield	shield

## Accuracy

<b>Linearity/Hysteresis</b>	< 1,0% FS	<b>Response sensitivity</b>	< 0,5% FS
<b>Repeatability</b>	< 0,5% FS	<b>Minimum setpoint</b>	100 mV (0.2 mA / 4.2 mA)
<b>Minimum outlet pressure</b>	1% FS	<b>Over all accuracy</b>	± 0,5% FS

## Adjustment and parameter settings

<b>Zero point / range</b>	Zero point and range can be calibrated percentagewise.
<b>Control mode / Amplification</b>	Through the software different control modes may be chosen. All parameters of P/PI/PID controllers can be tuned.
<b>Diagnosis</b>	A diagnostic tool including data recording is available within the software.
<b>Characteristic curve</b>	Increasing or decreasing curve can be set (increasing by standard).

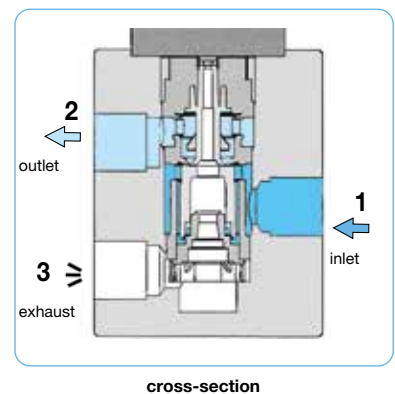
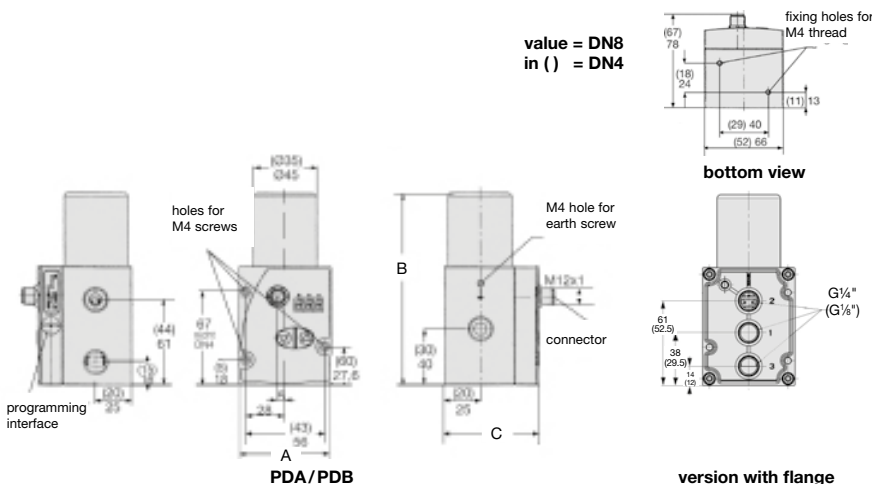

# PROPORTIONAL PRESSURE REGULATOR, PROGRAMMABLE

PD

<b>Description</b>	The proportional pressure regulator is digitally controlled and works as a 3/2 valve with proportional magnet and closed loop. The digital control system offers advantages at installation and commissioning for adapting the valve to special applications. The regulator can be set and optimised using a PC, PR adapter and software.		
<b>Media</b>	dry, lubricated, unlubricated and 50 µm filtered compressed air or non-corrosive gases		
<b>Supply voltage</b>	24 V DC ± 10 V, residual ripple < 10%		
<b>Signal range</b>	0-10 V, 100 kΩ impedance, 0/4-20 mA, 250 Ω impedance		
<b>Electrical connection</b>	plug M12x1, 5-pin, with coupling socket	<b>Pressure switch</b>	PNP, adjustable ± 5% from setpoint
<b>Power consumption</b>	21 W at DN4, 40 W at DN8		
<b>Linearity/Hysteresis</b>	< 0.5% FS / < 1% FS		
<b>Mounting position</b>	any		
<b>Temperature range</b>	fluid: 0 °C to 60 °C / 32 °F to 140 °F ambient: 0 °C to 50 °C / 32 °F to 122 °F		
<b>Material</b>	Body: aluminium	Elastomer: NBR/Buna-N	Inner valve: POM

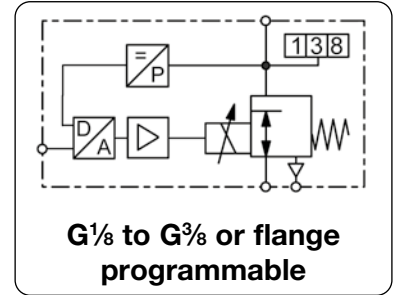

G<sup>1/8</sup> to G<sup>3/8</sup> or flange programmable

Dimensions			Nominal size	Flow rate	Supply max.	Connection thread	Pressure range	Order number
A	B	C	DN	l/min*1	bar	G	bar	E*
mm	mm	mm						

Proportional pressure regulator						0-10 V input and outlet signal, supply 24 V DC, without display, with coupling socket		PD	
52	112	67	4	0.43	470	6	G <sup>1/8</sup>	0 ... 1	PDA41-010
						6		0 ... 3	PDA41-030
						9		0 ... 5	PDA41-050
						9		0 ... 6	PDA41-060
						13		0 ... 8	PDA41-080
						13		0 ... 10	PDA41-100
						13		0 ... 12	PDA41-120
						6	G <sup>1/4</sup>	0 ... 1	PDA42-010
						6		0 ... 3	PDA42-030
						9		0 ... 5	PDA42-050
						9		0 ... 6	PDA42-060
						13		0 ... 8	PDA42-080
						13		0 ... 10	PDA42-100
						13		0 ... 12	PDA42-120
66	138	78	8	1.2	1300	6	G <sup>1/4</sup>	0 ... 1	PDA82-010
						6		0 ... 3	PDA82-030
						9		0 ... 5	PDA82-050
						9		0 ... 6	PDA82-060
						13		0 ... 8	PDA82-080
						13		0 ... 10	PDA82-100
						13		0 ... 12	PDA82-120
						6	G <sup>3/8</sup>	0 ... 1	PDA83-010
						6		0 ... 3	PDA83-030
						9		0 ... 5	PDA83-050
						9		0 ... 6	PDA83-060
						13		0 ... 8	PDA83-080
						13		0 ... 10	PDA83-100
						13		0 ... 12	PDA83-120



PDA without display



PDB with display



programming via PC

## Special options, add the appropriate letter or number

<b>display</b>	3-digit, red	PDB . . . .
<b>NPT</b>	connection thread	PD . . . . N
<b>0-20 mA</b>	setpoint input and monitor signal	PD . . . . 1
<b>4-20 mA</b>	setpoint input and monitor signal	PD . . . . 2
<b>flange version</b>		PD . . F . . .
	for PDA41/82	PD . . . . KU
<b>cascade regulation</b>	w/o monitor signal 2. sensor, electr. feedback 0-10 V	PD . . . . KI
	w/o monitor signal 2. sensor, electr. feedback 4-20 mA	

## Accessories, enclosed

<b>PR adapter</b>	with USB plug and 1 m cable	<b>PDUSB</b>
<b>software</b>	basic version "light"	<b>PDSOFT1*2</b>
<b>coupling socket</b>	M12x1, 5-pin, with 2 m cable, 5 x 0.25 angular 5 m cable, 5 x 0.25 angular	<b>KM12-C5-2</b> <b>KM12-C5-5</b>

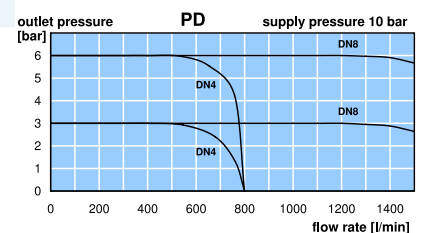

\*1 at 6 bar supply pressure and 5 bar outlet pressure  
\*2 You do not need any software to use the valve!

Technical details: see previous page

PDF CAD  
www.aircom.net



Order example:  
PDA41-010

<b>Description</b>	Piezo-operated proportional pressure regulator with closed loop in a two-wire system. Outlet pressure is proportional to an electrical input signal. The valve can be mounted in any position and is immune to shock or vibration. It is pilot-controlled to reach a higher flow rate.	
<b>Media</b>	lubricated or unlubricated and 50 µm filtered compressed air or non-corrosive gases	
<b>Supply voltage</b>	not necessary due to two-wire system (supply through 4...20 mA command signal)	
<b>Electrical connector</b>	coupling socket, 4-pin according to DIN 43651, size 15 x 15 mm	connector turnable in 90° steps
<b>ATEX classification</b>	Compliance with directive 2014/34/EU for use in potentially explosive atmosphere of group IIC, temperature classification T4.	
<b>Power consumption</b>	< 200 mW	Ignition protection type: II1G Ex ia IIC T4; II1D Ex D20 T135°C
<b>Linearity/Hysteresis</b>	< 1% FS	<b>Failsafe feature</b> exhaust at power breakdown
<b>Mounting position</b>	any	<b>Repeatability</b> < 0.5% FS
<b>Air consumption</b>	The pilot valve has an air consumption of 1.6 l/min	<b>Protection class</b> IP 65
<b>Temperature range</b>	Media: 0 °C to 60 °C / 32 °F to 140 °F	Ambient: 0 °C to 60 °C / 32 °F to 140 °F
<b>Material</b>	Body: aluminium and plastic	Elastomer: NBR/Buna-N and FKM
	Inner valve: stainless steel and plastic	

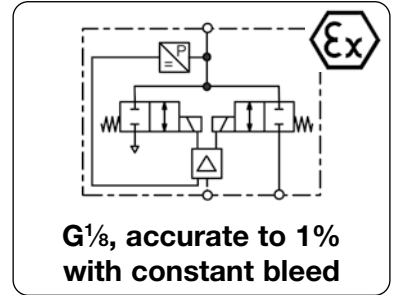

Dimensions			Nominal size	K <sub>v</sub> -value	Flow rate	Supply min./max.	Connection thread	Pressure range	Order number
A	B	C	DN	(m <sup>3</sup> /h)	l/min*1	bar	G	bar	
mm	mm	mm							E*

Proportional pressure regulator						4-20 mA input signal, ATEX with coupling socket, with constant bleed		PCEX	
42	143	36	4	0.5	550	2.5/3.0	G <sup>1</sup> / <sub>8</sub>	0...2	PCEX-02
						3.5/5.0		0...3	PCEX-03
						4.5/6.0		0...4	PCEX-04
						5.5/8.0		0...5	PCEX-05
						6.5/8.0		0...6	PCEX-06



PCEX

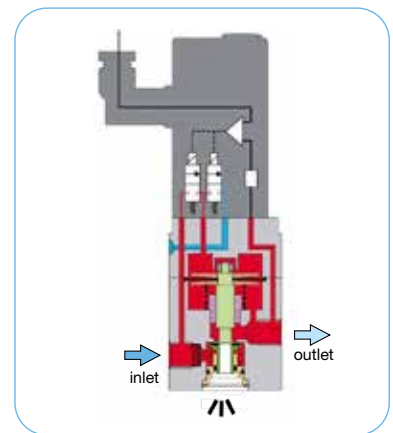

cross-section

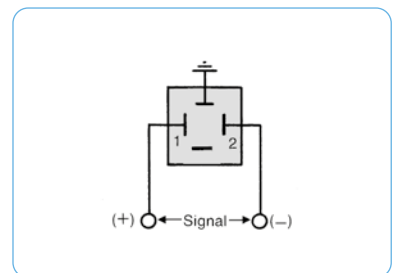
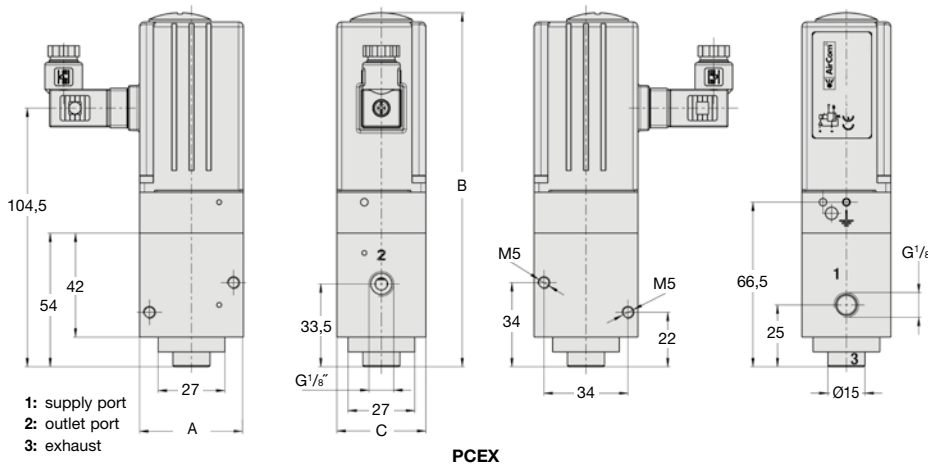

connection diagram

\*1 at 6 bar supply pressure, 5 bar outlet pressure, equal exhaust forward flow

\* Product group

<b>Description</b>	Proportional pressure regulator with closed loop control technology for better control of pressurised gases. The instrument can be built as single closed loop or dual closed loop control valve. dry, lubricated or unlubricated and 20 µm filtered compressed air or non-corrosive gases constant outlet pressure at voltage drop	
<b>Media</b>	dry, lubricated or unlubricated and 20 µm filtered compressed air or non-corrosive gases	
<b>Fail freeze</b>	constant outlet pressure at voltage drop	
<b>Second loop</b>	0-10 V, impedance 4.7 kΩ,	ratio of internal to external relationship is 10% to 90%
<b>Supply voltage</b>	15-24 V DC, residual ripple < 10%,	with reverse voltage protection
<b>Impedance</b>	0-10 V / 10 kΩ, 4-20 mA / 100 Ω	
<b>Protection class</b>	IP65	
<b>Electrical connector</b>	M12, 6-pin	
<b>Power consumption</b>	24 W (985 mA) regulating, 2.4 W (100 mA) non-regulating	
<b>Linearity/Hysteresis</b>	< 0.5% FS	
<b>Adjustment</b>	zero, span, hysteresis	<b>Repeatability</b> < 0.5% FS
<b>Temperature range</b>	0 °C to 70 °C / 32 °F to 158 °F	
<b>Material</b>	Ports: brass Transducer: silicon	<b>Mounting position</b> any, vibration-resistant <b>Elastomer:</b> FKM <b>Valves:</b> stainless steel

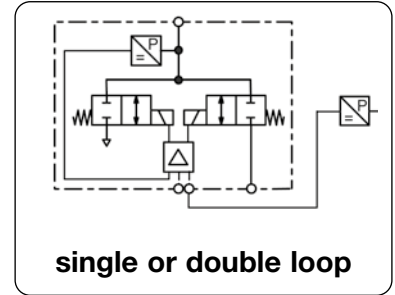

Dimensions			K <sub>v</sub> -value (m <sup>3</sup> /h)	Flow rate l/min*1	Supply pressure max. bar	Accuracy %	Connection thread G	Pressure range bar	Order number
A	B	C							
mm	mm	mm							

Proportional pressure regulator									
0-10 V input and monitor signal, w. coupling socket supply voltage 24 V DC, single loop									PQH1
76	122	15	0.016	280	75	0.5	G $\frac{1}{8}$	0 ... 40	PQH1EE-40
								0 ... 50	PQH1EE-50
								0 ... 60	PQH1EE-60
								0 ... 70	PQH1EE-70

Proportional pressure regulator									
0-10 V input, monitor- and feedback signal, with coupling socket, supply volt. 24 V DC, double loop									PQH2
76	122	15	0.016	280	75	0.5	G $\frac{1}{8}$	0 ... 40	PQH2EE-40
								0 ... 50	PQH2EE-50
								0 ... 60	PQH2EE-60
								0 ... 70	PQH2EE-70



PQH1

### Special options, add the appropriate letter or number

4-20 mA	input and feedback signal	PQH . IC- ..
for oxygen		PQH . . . . .15
stainless steel manifold		PQH . . . . .SS

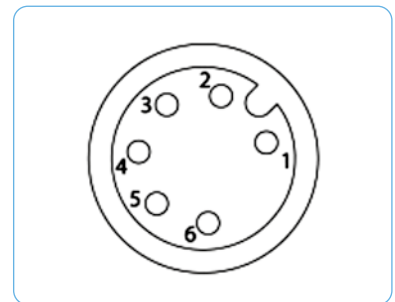
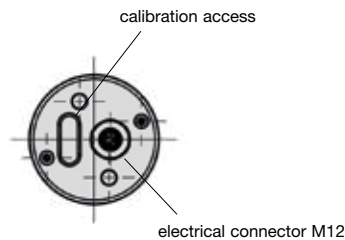
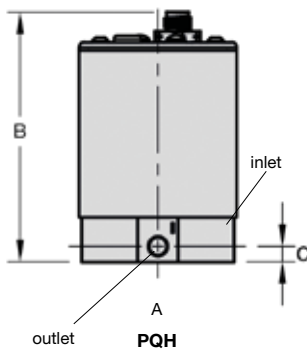

view from solder pin side

Pin	Description
1	TTL output
2	set point +
3	set point ground
4	supply 24V DC
5	supply earth
6	analogue output signal

connection plan

\*1 at 70 bar supply pressure and open outlet

For further details about double loop see end of the chapter

PDF CAD  
www.aircom.net

\* Product group



Order example:  
PQH1EE-40



<b>Description</b>	The proportional pressure regulator translates a direct current or voltage input signal into a proportional pneumatic outlet signal. The valve uses proven moving coil and flapper nozzle technology with a built-in pneumatic relay with slight amplification and positive bias. Additional supply voltage is not necessary. The device has to be protected against vibration.
<b>Media</b>	5 µm filtered compressed air or non-corrosive gases
<b>Supply voltage</b>	not required
<b>Electrical connector</b>	plug according to DIN 43650A, contact gap 18 mm, 3-pin, with coupling socket 30 x 30 mm
<b>Command signal</b>	0...10 V / 1.1 kΩ at PT6...-B, otherwise 900 Ω      4...20 mA / 200 Ω at PT6...-0, otherwise 260 Ω
<b>Failsafe</b>	exhaust at power breakdown
<b>Linearity</b>	< 0.5 % FS at 0.2...2 bar, otherwise < 1% FS
<b>Hysteresis</b>	< 0.25% FS at 0.2...2 bar, otherwise < 1% FS
<b>Adjustment</b>	Zero point: by 0.3 bar      Range: 40% FS
<b>Temperature range</b>	-30 °C to 65 °C / -22 °F to 149 °F
<b>Material</b>	Body: chromated aluminium Nozzle: sapphire in nickel-plated brass plate
	<b>Response sensitivity</b> < 0.2% FS <b>Repeatability</b> < 0.1% FS <b>Vibration sensitivity</b> < 2% FS, for 10 g and 15...500 Hz <b>Mounting position</b> upright ± 15° <b>Protection class</b> IP 65 Elastomer: NBR/Buna-N Inner valve: stainless steel, brass, zinc-plated steel

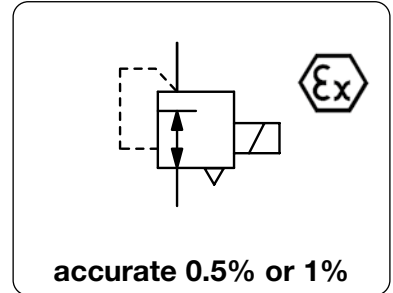

Dimensions			Flow rate	Supply pressure	Command signal	Pressure range	Order number
A	B	C	l/min*1	max. bar	V/mA	bar	
mm	mm	mm					

Proportional pressure regulator 0-10 V							¼ NPT, depending on pressure range air consumption 2...8 l/min	PT600
57	93	13	250	8	0-10 V	0.2...1	PT600-B100	
						0.2...2	PT600-B200	
57	132	13	300	10	0-10 V	0...2	PT600-0200	
						0...4	PT600-0400	
						0...8	PT600-0800	

Proportional pressure regulator 4-20 mA							¼ NPT, depending on pressure range air consumption 2...8 l/min	PT602
57	93	13	250	8	4-20 mA	0.2...1	PT602-B100	
						0.2...2	PT602-B200	
57	132	13	300	10	4-20 mA	0...2	PT602-0200	
						0...4	PT602-0400	
						0...8	PT602-0800	



**Special options, change the appropriate number**

<b>Ex-i-Atex</b>	Atex II 1G Ex ia IIC T4	4-20 mA only	PT602-...01
------------------	-------------------------	--------------	-------------

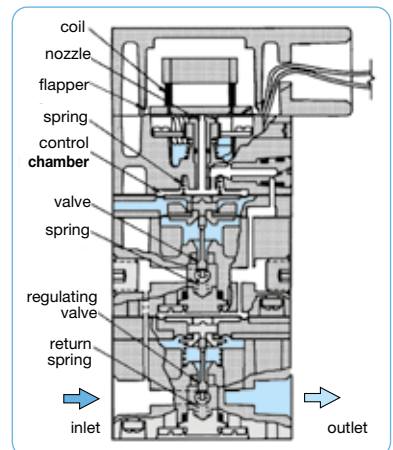

**Accessories, enclosed**

<b>mounting bracket</b>	made of steel, for standard version	<b>SA-PT1</b>
	made of steel, for Din rail	<b>SA-PT2</b>
<b>isolate transmitter</b>	Ex ia II C, E/A: 0-20 mA, 24 V DC, EX 1-32	<b>KFD2-CD</b>

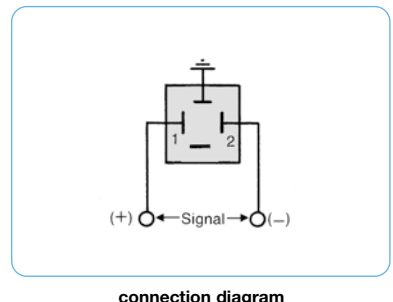
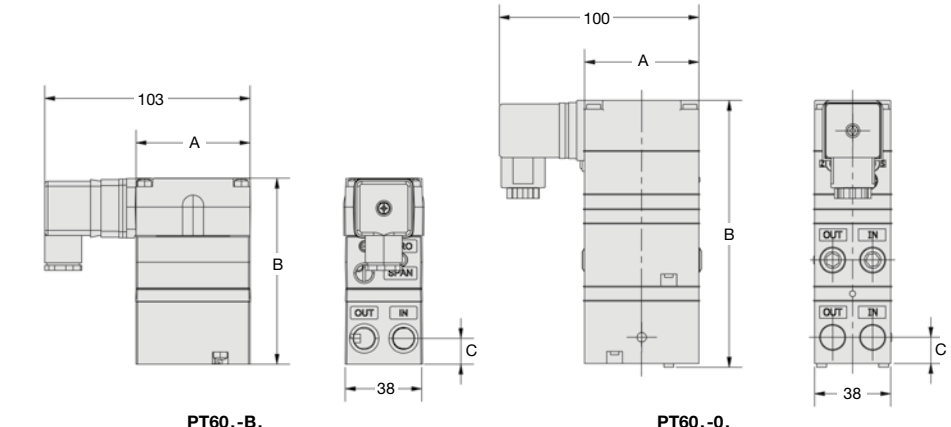

\*1 at 7 bar supply pressure and 1.4 bar outlet pressure

\* Product group

**Order example: PT600-B100**

PDF CAD  
www.aircom.net

# PROPORTIONAL PRESSURE REGULATOR WITH PIEZO ELEMENT AND ELECTRICAL FEEDBACK PT7

<b>Description</b>	The proportional pressure regulator translates a direct current or voltage signal into a linear proportional pneumatic outlet signal. With rapid response controls using low-powered piezo microelectronics, flapper nozzle and solid state control circuit. The proportional pressure regulator has internal electronic with an electrical feedback sensor and is housed in NEMA4X (IP65) enclosure with six outlet ranges, jumper selectable. Input and outlet ports on both ends of the body simplify pneumatic piping.	
<b>Media</b>	5 µm filtered compressed air or non-corrosive gases	
<b>Supply voltage</b>	7...30 V DC, 90 mW, required for 0...10 V setpoint input only, with reverse voltage protection	
<b>Electrical connector</b>	plug according to DIN 43650A, contact gap 18 mm, 3-pin, with coupling socket 30 x 30 mm	
<b>Command signal</b>	0...10 V / 10 kΩ, 3-pin, 24 V DC supply voltage, 4...20 mA / 330 Ω, two-wire, min. 7 V DC on input	
<b>Failsafe</b>	exhaust at power breakdown	
<b>Linearity</b>	< 0.25% FS	
<b>Hysteresis</b>	< 0.1% FS at 0.2...0.5 bar, otherwise < 0.25% FS	
<b>Adjustment</b>	Zero point: by 0.3 bar Range: 40% FS	
<b>Temperature range</b>	-40 °C to 70 °C / -40 °F to 158 °F	
<b>Material</b>	Body: chromated aluminium Nozzle: sapphire in nickel-plated brass plate Response sensitivity < 0.2% FS Repeatability < 0.1% FS Vibration sensitivity < 1% FS, for 10 g and 15...500 Hz Mounting position any Protection class IP 65 Elastomer: NBR/Buna-N Inner valve: stainless steel, brass, zinc-plated steel	

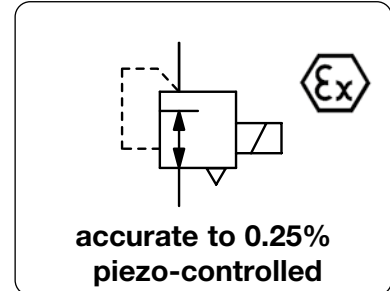

Dimensions			Flow rate l/min*1	Supply pressure max. bar	Command signal V/mA	Pressure range bar	Order number
A	B	C					

Proportional pressure regulator 0-10 V							
¼" NPT, air consumption 2...8 l/min subject to pressure range							<b>PT780</b>
57	95	13	250	8	0-10 V	0.2...1	<b>PT780-B100</b> <b>PT780-B200</b>
57	133	13	300	10	0-10 V	0...2 0...4 0...8	<b>PT780-0200</b> <b>PT780-0400</b> <b>PT780-0800</b>



Proportional pressure regulator 4-20 mA							
¼" NPT, air consumption 2...8 l/min subject to pressure range							<b>PT782</b>
57	95	13	250	8	4-20 mA	0.2...1	<b>PT782-B100</b> <b>PT782-B200</b>
57	133	13	300	10	4-20 mA	0...2 0...4 0...8	<b>PT782-0200</b> <b>PT782-0400</b> <b>PT782-0800</b>

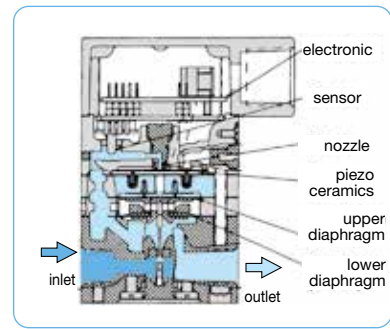

Special options, change the appropriate number							
	<b>-i-Atex</b>	Atex II 1G Ex ia IIB T4			4-20 mA only		<b>PT782-...01</b>
	<b>-d-Atex</b>	Atex ds IIC T6	max. 2 bar		4-20 mA only		<b>PT782-...0E</b>

## Accessories, enclosed

<b>mounting bracket</b>	made of steel, for standard version	<b>SA-PT1</b>
	made of steel, for DIN rail	<b>SA-PT2</b>
<b>mounting clip</b>	made of steel, Atex version, explosion-proof	<b>SA-PT3</b>
<b>isolate transmitter</b>	Ex ia II C E/A: 0...20 mA, 24 V DC, EX 1-32	<b>KFD2-CD</b>

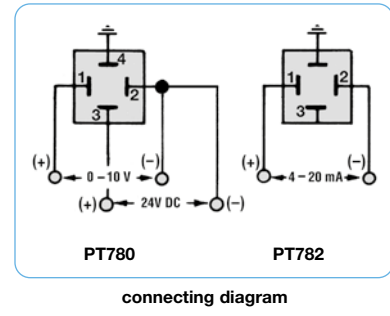
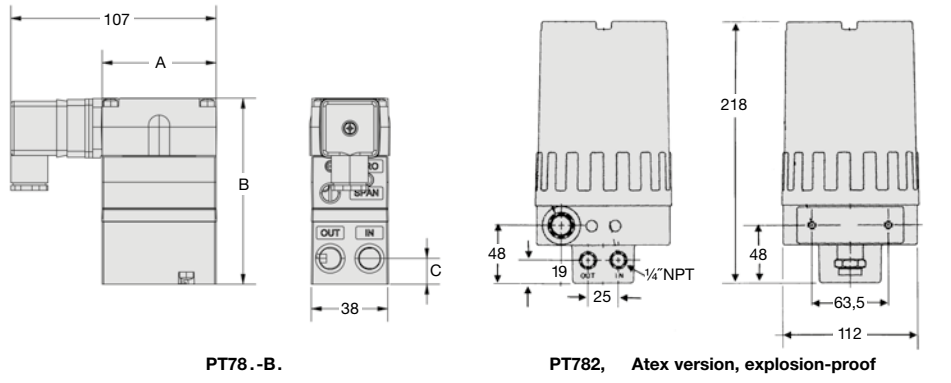
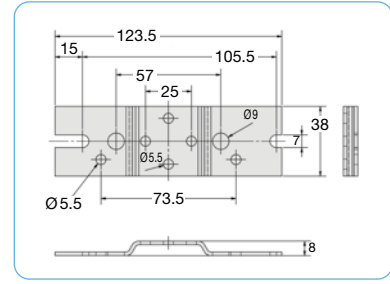

\*1 at 7 bar supply pressure and 1.4 bar outlet pressure

\* Product group

### Description

Piezo-operated proportional pressure regulator based on the principle of a piezo element which bends when voltage is applied. At the end of the piezo element is a flapper valve, which operates against a precision nozzle to create back pressure on the control diaphragm of a booster relay. A pressure transducer provides feedback of the outlet pressure compared with the setpoint value with correction by the electronic control system if necessary.

### Minimal power consumption

- no self-heating, even none at pressure absence
- safe battery operation over a long period
- almost no power consumption necessary for regulation
- extremely quick regulating operations
- low-noise regulation especially for medical and laboratory technology
- particularly suitable for portable devices in conjunction with battery operation
- ideal for limited space conditions

### Piezo element

### Small and light design

### PRE1

DN 2.5, 350 l/min, coupling socket M8x1, 3-pin,  
monitor signal optionally 0... $P_{2max}$   $\triangleq$  0...10 V,

monitor signal, 4-pin  
max. 1 mA,  $R_a > 1k\Omega$

### PRE2

DN 6, 1600 l/min, coupling socket M12x1.5, 5-pin  
monitor signal standard 0... $P_{2max}$   $\triangleq$  0...10 V,

max. 1 mA,  $R_a > 1k\Omega$

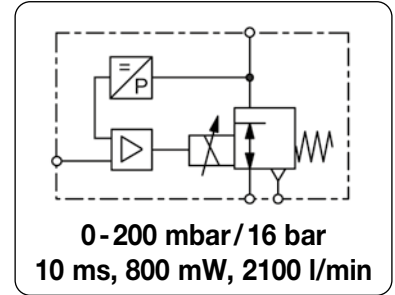

## General features

<b>Description</b>	Piezo-operated 3-port/2-way proportional pressure regulator with internal pressure sensor and closed loop.		
<b>Protection class</b>	IP 30 for PRE1 according to DIN EN 60529 IP 65 for PRE2 according to DIN EN 60529 with coupling socket and tapped exhaust		
<b>Mounting position</b>	any		
<b>Temperature range</b>	0 °C to 50 °C / 32 °F to 122 °F		
<b>Material</b>	Body: plastic, PRE1 IXEF1022	PRE2 Grivity GVX-65H	Elastomer: NBR/Buna-N Inner valve: brass and spring steel

## Pneumatic features

<b>Media</b>	dry, unlubricated and 5 $\mu$ m filtered compressed air or non-corrosive gases		
<b>Supply pressure</b>	min. 1.5 bar (at $P_2 \leq 8$ bar) or 2 bar (at $P_2 \geq 8$ bar) and additional $P_1$ : min. 1 bar greater than $P_2$ max. 2.5 bar up to 17 bar, depending on pressure range according to chart		
<b>Flow rate</b>	PRE1: max. 350 l/min at $P_1 = 10$ bar, $P_2 = 6$ bar and open outlet	DN 2.5	
	PRE2: max. 1600 l/min at $P_1 = 10$ bar, $P_2 = 6$ bar and open outlet	DN 6	
<b>Exhaust</b>	PRE1: 180 l/min at $P_2 = 6$ bar, 20 l/min at $P_2 = 200$ mbar		
	PRE2: 1000 l/min at $P_2 = 6$ bar, 400 l/min at $P_2 = 2$ bar		
<b>Air consumption</b>	PRE1: < 1.0 l/min independent of pressure range PRE2: < 1.0 l/min independent of pressure range		

## Electrical features

<b>Supply voltage</b>	PRE1: 24 V DC $\pm$ 10%, 0.4 W, current consumption max. 15 mA PRE2: 24 V DC $\pm$ 10%, 0.8 W, current consumption max. 30 mA		
<b>Command signal</b>	4...20 mA or 0...10 V		
<b>Impedance</b>	PRE1: $\geq 66 k\Omega$ at voltage signal, $\leq 500 \Omega$ at current signal		
	PRE2: $\geq 55 k\Omega$ at voltage signal, $\leq 500 \Omega$ at current signal		
<b>Electrical connector</b>	PRE1: coupling socket M8x1, 3-pin	PRE1-R: coupling socket M8x1, 4-pin	
	PRE2: coupling socket M12x1.5, 5-pin		
<b>Monitor signal</b>	PRE1-U.R: as option 0... $P_{2max}$ / 0...10 V, max. 1 mA, $R_a > 1k\Omega$		
	PRE2: standard 0... $P_{2max}$ / 0...10 V, max. 1 mA		
<b>Electronic switch</b>	PRE2 only, PNP, "on" when setpoint and actual value match in the tolerance range 0 V DC = off, $U_N = -0.7$ V DC = on, output current < 200 mA, tolerance $P_2: \pm 2\%$		
<b>Failsafe</b>	If signal or electrical supply fails, outlet pressure falls to zero and the regulator exhausts.		
<b>Note</b>	For long connection lines shielding is to be used. Pay attention to voltage drops. As the case may be, current signal is preferable.		

## Accuracy

<b>Linearity</b>	< 0.5% FS, at 0.2 bar range	< 1 % FS
<b>Hysteresis</b>	< 0.2% FS, at 0.2 bar range	< 0.5% FS
<b>Response sensitivity</b>	< 0.1% FS, at 0.2 bar range	< 0.5% FS at PRE1 < 0.2% FS at PRE2
<b>Repeatability</b>	< 0.2% FS, at 0.2 bar range	< 0.5% FS
<b>Response time</b>	10 ms	
<b>Over all accuracy</b>	$\pm 0.2\%$ FS (Monitor signal $\pm 1.5\%$ FS)	

## Adjustment

<b>Zero point</b>	calibration only by factory
<b>Range</b>	calibration only by factory

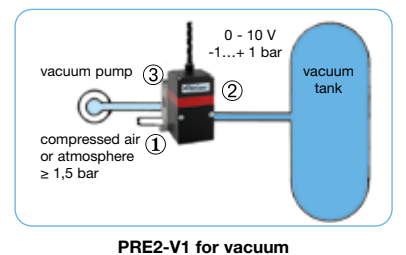
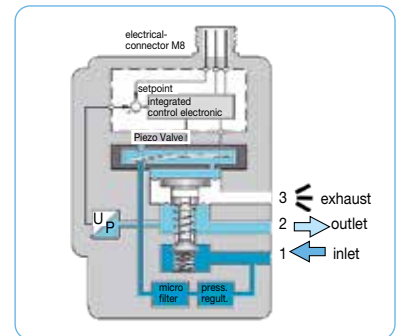
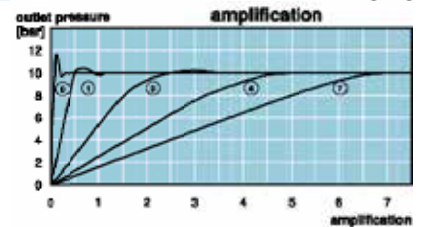
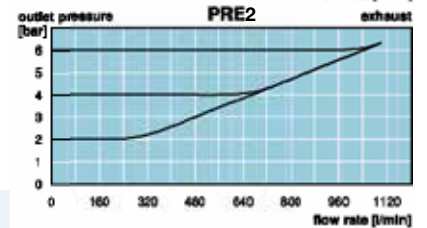
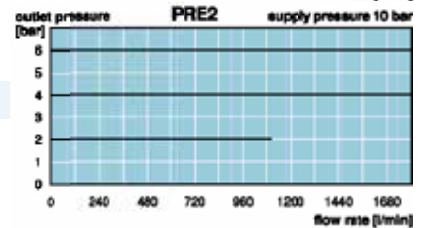
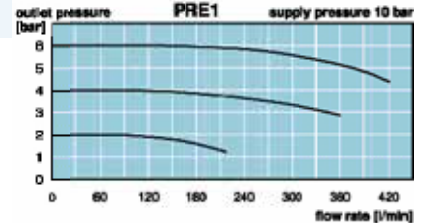

### Technical features

- Highly dynamic** 10 ms, critical frequency 43 Hz
- Low power consumption** 400 mW / 800 mW nominal power
- No self-heating** due to low power consumption
- Battery operation** due to low power consumption
- For portable devices** up to 3 bar pressure range
- No over-oscillation** adjustable closed loop amplification
- No resonance oscillation** adjustable closed loop amplification
- Linearity** < 0.5% or 1% FS
- Hysteresis** < 0.2% or 0.5% FS
- Response sensitivity** < 0.1% or 0.5% FS
- Repeatability** < 0.2% or 0.5% FS
- Failsafe** exhaust at power breakdown
- Protection class** IP 30 or IP 65
- Two-wire system** for signal 4...20 mA

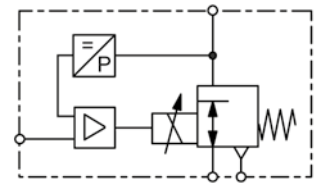

**0 ... 200 mbar / 16 bar**  
**10 ms, 800 mW, 2400 l/min**

Dimensions			Supply pressure	Flow rate	Connection thread	Pressure range	Order number for inlet signal	
A	B	C	max. bar	l/min*1	G	bar	4-20 mA	0-10 V
mm	mm	mm						

Proportional press. regl.						supply voltage 24 V DC, constant bleed, with straight coupling socket and 5 m cable	PRE	PRE
36	61	53	2.5	100	G $\frac{1}{8}$	0...0.2	PRE1-IA2	PRE1-UA2
			6.0	200		0... 2	PRE1-IO2	PRE1-UO2
			10	250		0... 5	PRE1-IO5	PRE1-UO5
				280		0... 6	PRE1-IO6	PRE1-UO6
				350		0... 8	PRE1-IO8	PRE1-UO8
46	84	68	2.5	800	G $\frac{1}{4}$	-1... 1	PRE2-IO1V1	PRE2-UO1V1
			10	1500		-1... 4	PRE2-IO4V1	PRE2-UO4V1
				1500		-1... 6	PRE2-IO6V1	PRE2-UO6V1
			12	1700		-1... 10	PRE2-IO10V1	PRE2-UO10V1
			2.5	500		0... 0.5	PRE2-IA5	PRE2-UA5
				900		0... 1	PRE2-IO1	PRE2-UO1
			7.0	1100		0... 2	PRE2-IO2	PRE2-UO2
				1100		0... 3	PRE2-IO3	PRE2-UO3
			10	1500		0... 4	PRE2-IO4	PRE2-UO4
				1500		0... 5	PRE2-IO5	PRE2-UO5
				1500		0... 6	PRE2-IO6	PRE2-UO6
			12	1700		0... 10	PRE2-IO10	PRE2-UO10
			17	2400		0... 16	PRE2-IO16	PRE2-UO16



PRE1



PRE2

### Special options, add the appropriate letter

<b>monitor signal</b>	0-10 V, standard at PRE2	for PRE1-U	PRE1-...R
<b>flange connection</b>	without manifold		PRE-...F
<b>w/o coupling socket</b>	and without cable		PRE-...H
<b>mounting clips</b>	for DIN rail		PRE-...C
<b>deviant pressure ranges</b>			PRE-...XX
<b>for oxygen*2</b>	specially cleaned		PRE-...15

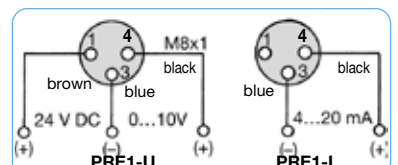

connection diagram

### Accessories, enclosed

<b>coupling socket</b>	with 5 m cable, angular	M8x1, 3-pin	for PRE1	<b>KM08-C3-5</b>
		M8x1, 4-pin	for PRE1-R	<b>KM08-C4-5</b>
		M12x1.5, 5-pin	for PRE2	<b>KM12-C5-5</b>

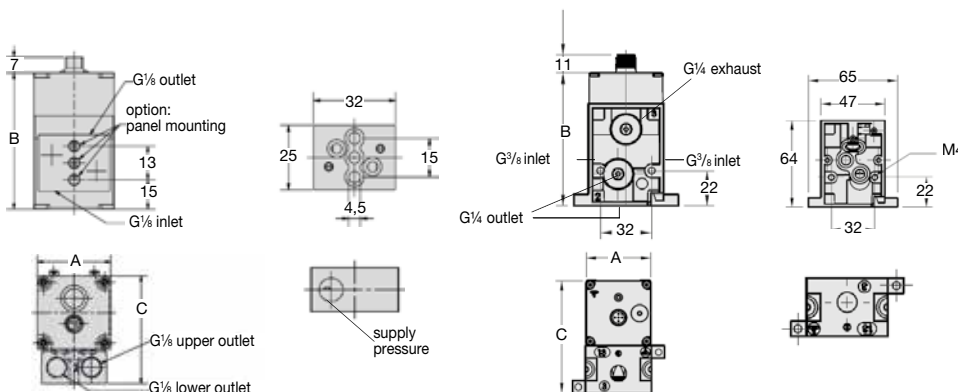

\*1 at open outlet  
 \*2 by PRE1 no tapped exhaust on the manifold

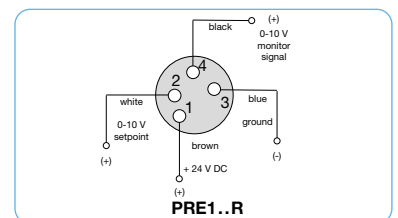

connection diagram

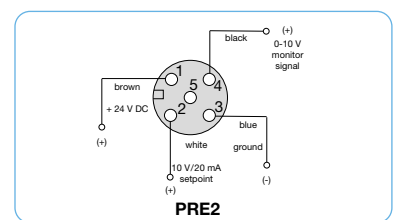

connection diagram

\* Product group

Technical details: see previous page

PDF CAD  
 www.aircom.net



Order example:  
**PRE1-IA1**

<b>Description</b>	The pneumatic proportional pressure regulator controls the outlet pressure in a complete closed loop servo system in proportion to an digital IO-Link command signal. By using the IO-Link Master the valve can be adapted to special applications and optimize the the response time, the overshoot and the precision of the valve. The valve has no constant bleed. At absence of input signal or supply voltage the pressure of the valve stands.		
<b>Media</b>	dry, lubricated, unlubricated and 50 µm filtered compr. air or non-corrosive gases		
<b>Command signal</b>	Digital command signal in 1mbar steps (0-10000 = 0-10 bar)	<b>Control</b>	IO-Link (Class A)
<b>Hysteresis</b>	1,5% FS	<b>Supply voltage</b>	24 VDC
<b>Linearity</b>	1,5% FS	<b>Electrical connector</b>	M12, 5-pin
<b>Repeatability</b>	1,5% FS	<b>Protection class</b>	IP65
<b>Minimum Command signal</b>	0,5% FS	<b>Current consumption</b>	180 mA
<b>Minimum Outlet Pressure</b>	1,0% FS	<b>Power consumption</b>	3,8 W (< 1W if regulated)
<b>Temperature range</b>	0-60 °C Media and Ambient		
<b>Material</b>	Body: aluminium	Inner valve: POM (Polyacetal)	Elastomer: NBR
<b>Mounting position</b>	any, preferably perpendicular		

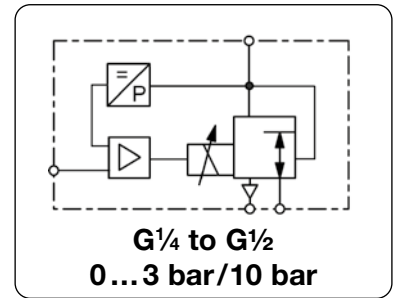

Dimensions			K <sub>v</sub> -value	Flow rate	Supply pressure	Connection thread	Pressure range	Order number
A	B	C	(m <sup>3</sup> /h)	(m <sup>3</sup> /h)	l/min	G	bar	

Proportional pressure regulator						Supply 24 V DC via IO-Link master without coupling socket		PIO	
52	115	73	0.43	28,2	470	4	G <sup>1</sup> / <sub>4</sub>	0 ... 3	<b>PIO2-03</b>
						7	G <sup>1</sup> / <sub>4</sub>	0 ... 6	<b>PIO2-06</b>
						11	G <sup>1</sup> / <sub>4</sub>	0 ... 10	<b>PIO2-10</b>
66	129	89	1.2	78	1300	4	G <sup>3</sup> / <sub>8</sub>	0 ... 3	<b>PIO3-03</b>
						7	G <sup>3</sup> / <sub>8</sub>	0 ... 6	<b>PIO3-06</b>
						11	G <sup>3</sup> / <sub>8</sub>	0 ... 10	<b>PIO3-10</b>
66	144	102	4.8	312	5200	4	G <sup>1</sup> / <sub>2</sub>	0 ... 3	<b>PIO4-03</b>
						7	G <sup>1</sup> / <sub>2</sub>	0 ... 6	<b>PIO4-06</b>
						11	G <sup>1</sup> / <sub>2</sub>	0 ... 10	<b>PIO4-10</b>



PIO

### Special options, add the appropriate letter or number

<b>Display</b>	PIO-... <b>B</b>
<b>for oxygen</b>	PIO-... <b>15</b>

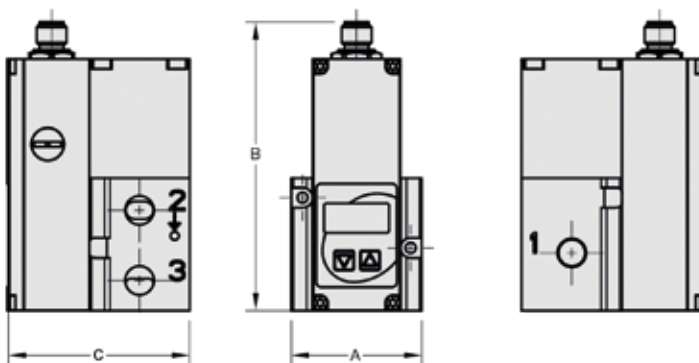

- 1: inlet
- 2: outlet
- 3: exhaust

PIO

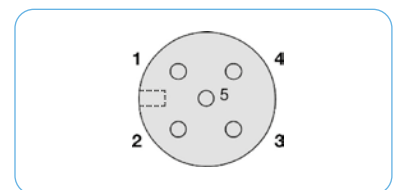

view from solder pin side

Pin	Description
1	24V supply voltage
2	not occupied
3	supply ground
4	C/Q
5	not occupied
Housing	EMC shield

connection plan

\*1 To use the valve, you need the IODD  
P1 = at least 1 bar higher than the maximum outlet pressure

\* Product group

PDF CAD  
www.aircom.net



Order example:  
PIO2-03

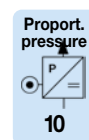



# SETPOINT POTENTIOMETER

PPB

<b>Description</b>	The series line of potentiometers are designed for use as a command signal for control pressure regulators.		
	A 10 volt reference is used to provide excitation to the potentiometer. An op-amp measures the output on the wiper of the potentiometer and provides buffering to eliminate external components from affecting the linearity of the potentiometer.		
	A three wire cord is provided and is attached to the pc board to make necessary power signal and common connections		
<b>Field of application</b>	0-10 V version PPB-U is compatible with all proportional pressure regulators. 4-20 mA version PPB-I is compatible with all pressure regulators of Series PQ and PM. For all other pressure regulators, e.g Series PP, PR, PRE, a setpoint of 4.1 ... 18.5 mA is generated.		
<b>Measuring range</b>	0 ... 999	<b>Supply voltage</b>	15 - 24 V DC
<b>Current consumption</b>	max. 30 mA	<b>Linearity/Hysteresis</b>	± 0.25% FS
<b>Mounting position</b>	any	<b>Temperature range</b>	0 °C to 70 °C / 32 °F to 158 °F

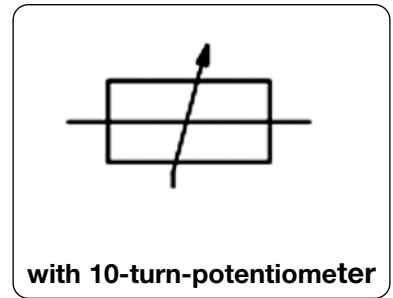

Dimensions			Output signal V / mA	Order number
F	H	G		
mm	mm	mm		

Setpoint Potentiometer			supply voltage 15 - 24 V DC	PPB
85	55	40	0-10 V	PPB-U
85	55	40	4-20 mA	PPB-I



PPB-U



PPB-I

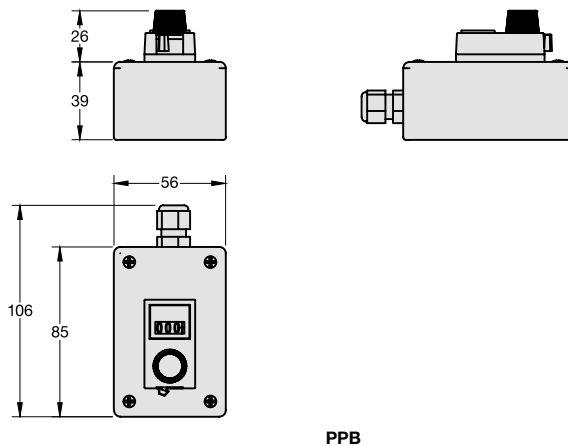

Pin	Description	3-pin cable
1	voltage supply 24V DC	black
2	analogue setpoint	white
3	supply earth	green

connecting plan

\* Product group

PDF CAD  
www.aircom.net



Order example:  
PPB-U

# VOLUME BOOSTER-PROPORTIONAL PRESS. REGL.-COMBINATIONS

## What are volume booster / proportional pressure regulator combinations used for?

Combinations of volume boosters and proportional pressure regulator lend themselves for electronically regulating high volume flows. On the one hand common proportional pressure regulator are not available with connection sizes big enough, on the other hand combinations are in most cases more economic. There are two ways of regulating: Single loop systems are suitable for standard applications without high requirements for accuracy and without consideration of pressure drop at high flow. Double loop regulations on the contrary are much more accurate and also qualified for dynamic processes.

## General operational description:

The volume booster and proportional pressure regulator are fed by the supply pressure. When no command signal is applied the outlet pressure behind the booster is zero. When the command signal is increased the outlet pressure rises in proportion to it. Since the transmission ratio is not exactly 1:1, a slight pressure difference occurs between the outlet pressure of the proportional pressure regulator and the booster's outlet on single loop systems. This can be balanced by a feedback signal (double loop), though.

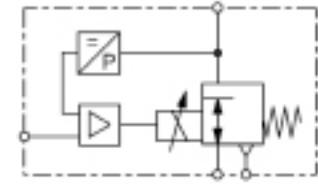

**G $\frac{1}{4}$  up to G3  
compressed air or liquids**

## Single loop

At single loop combinations the pressure difference between command signal and outlet pressure is being ignored because the proportional pressure regulator only refers to its own outlet pressure within the pilot chamber. The outlet pressure performance is dependent of the volume booster's accuracy.

## Double loop

Combinations with a second feedback have the possibility to balance pressure differences. For this a pressure transducer is installed in the outlet line of the booster. The electrical signal of the transducer is applied as a feedback signal onto the proportional pressure regulator. The proportional pressure regulator detects any pressure differences and compensates them automatically. In high flow applications a pressure drop at the outlet of the pilot regulator is thus minimised.

## General features

<b>Construction type</b>	The volume booster / proportional pressure regulator combinations are delivered completely assembled and calibrated.
<b>Mounting position</b>	preferred horizontal (see figure)
<b>Protection class</b>	IP 54 with ordinary coupling socket as standard, optionally IP 65 for some devices (see according product information sheets)
<b>Temperature range</b>	0 °C to 50 °C / 32 °F to 122 °F for all proportional pressure regulator, for booster ranges refer to according product sheets

## Pneumatic features

<b>Command signal</b>	The proportional pressure regulator may only be fed with dry and 5 µm filtered compressed air. The pneumatic command signal must always be air!
<b>Media</b>	Preferred dry, 5 µm filtered compressed air for supply of the proportional pressure regulator. The volume boosters can operate with air or non-corrosive gases, model R120 even with liquids. The respective air consumption and the relieving function strongly have to be regarded.
<b>Inlet pressure</b>	dependent of the according combination (see according product information sheets)
<b>Pressure supply</b>	The proportional pressure regulator has to be separately supplied with compressed air with regard to the valve's maximum inlet pressure.
<b>Exhaust</b>	The proportional pressure regulator exhausts only the booster's pilot chamber. The booster, if in relieving version, exhausts the volume of the supply pressure line. The relief capacity is subject to the differential pressure.
<b>Volume flow</b>	see specifications of the according volume booster

## Electrical features

<b>Supply voltage</b>	All valves have to be supplied with 24 V DC.
<b>Power consumption</b>	see according product information sheets
<b>Setpoint input</b>	0-10 V as standard, optionally 4-20 mA for all valves
<b>Monitor signal</b>	A feedback signal is not reasonable for the single loop version because here only the pressure of the booster's pilot chamber is monitored. That value does not give any information about the outlet pressure behind the booster.

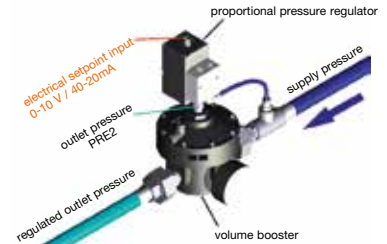

**PRE2, R450 with single loop**

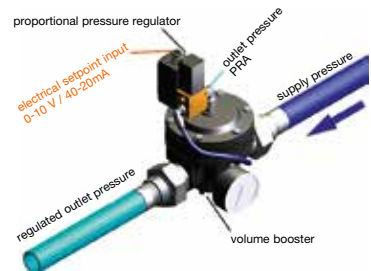

**PRA, R119 with single loop**

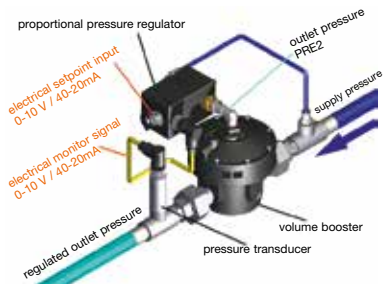

**PQ2, R450 with double loop**

### General operational description:

The volume booster and proportional pressure regulator are fed by the supply pressure. When no command signal is applied the outlet pressure behind the booster is zero. When the command signal is increased the outlet pressure rises in proportion to it. Since the transmission ratio is not exactly 1:1, a slight pressure difference occurs between the outlet pressure of the proportional pressure regulator and the booster's outlet on single loop systems. This can be balanced by a feedback signal (double loop), though.

At single loop combinations the pressure difference between command signal and outlet pressure is being ignored because the proportional pressure regulator only refers to its own outlet pressure within the pilot chamber. The outlet pressure performance is dependent of the volume booster's accuracy.

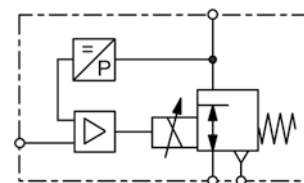

**G<sup>1</sup>/<sub>4</sub> up to G3  
compressed air or liquids**

## Single loop combination examples

Flow rate l/min	Connection thread G	Outlet pressure bar	Part number Booster	Part number Prop.press.reg.	Order number of combination	E*
--------------------	---------------------------	---------------------------	------------------------	--------------------------------	--------------------------------	----

### R750 with PRE1, for compressed air or non-corrosive gases setpoint 0-10 V, P<sub>1</sub> max. 17 bar

1000	G <sup>1</sup> / <sub>4</sub>	0... 8	R750-02I	PRE1-U08	<b>BP1U750-02</b>	
------	-------------------------------	--------	----------	----------	-------------------	--

### R450 with PRE1, for compressed air or non-corrosive gases setpoint 0-10 V, P<sub>1</sub> max. 17 bar

4000	G <sup>1</sup> / <sub>2</sub>	0... 8	R450-04I	PRE1-U08	<b>BP1U450-04</b>	
------	-------------------------------	--------	----------	----------	-------------------	--

### R119 with PPA, for compressed air or non-corrosive gases setpoint 0-10 V, P<sub>1</sub> max. 21 bar

5600	G <sup>1</sup> / <sub>2</sub>	0... 10	R119-04J	PPA00-1000	<b>BP1U119-04</b>	
9000	G <sup>3</sup> / <sub>4</sub>	0... 10	R119-06J	PPA00-1000	<b>BP1U119-06</b>	
10000	G1	0... 10	R119-08J	PPA00-1000	<b>BP1U119-08</b>	
12000	G1 <sup>1</sup> / <sub>2</sub>	0... 10	R119-12J	PPA00-1000	<b>BP1U119-12</b>	
42000	G2	0... 10	R119-16J	PPA00-1000	<b>BP1U119-16</b>	
44000	G2 <sup>1</sup> / <sub>2</sub>	0... 10	R119-20J	PPA00-1000	<b>BP1U119-20</b>	
110000	G3	0... 10	R119-24J	PPA00-1000	<b>BP1U119-24</b>	

### RGB4 with PRE1-A2, for compressed air or gases setpoint 0-10 V, P<sub>1</sub> max. 4 bar

700	G <sup>1</sup> / <sub>2</sub>	0...0,2	RGB4-04J	PRE1-UA2	<b>BP1UGB4-04</b>	
2800	G1	0...0,2	RGB4-08J	PRE1-UA2	<b>BP1UGB4-08</b>	
5600	G1 <sup>1</sup> / <sub>2</sub>	0...0,2	RGB4-12J	PRE1-UA2	<b>BP1UGB4-12</b>	

### RZ1 with PRE1-.01/02, for compressed air or gases setpoint 0-10 V, P<sub>1</sub> max. 16 bar

2900	G1	0... 1	RZ3-08J	PRE1-U02	<b>BP1UZ-08</b>	
5700	G1 <sup>1</sup> / <sub>2</sub>	0... 1	RZ3-12J	PRE1-U02	<b>BP1UZ-12</b>	
21000	G2	0... 1	RZ2-16J	PRE1-U02	<b>BP1UZ-16</b>	

### R120 with PPA, for compressed air, gases or liquids setpoint 0-10 V, P<sub>1</sub> max. 50 bar

1200	G <sup>1</sup> / <sub>2</sub>	0... 15	R120-04J2	PPA00-1600	<b>BP1U120-04</b>	
4200	G <sup>3</sup> / <sub>4</sub>	0... 15	R120-06J2	PPA00-1600	<b>BP1U120-06</b>	
5000	G1	0... 15	R120-08J2	PPA00-1600	<b>BP1U120-08</b>	
1200	G <sup>1</sup> / <sub>2</sub>	0... 50	R120-04J5	PP000-5000	<b>BP1U120-04J5</b>	
4200	G <sup>3</sup> / <sub>4</sub>	0... 50	R120-06J5	PP000-5000	<b>BP1U120-06J5</b>	
5000	G1	0... 50	R120-08J5	PP000-5000	<b>BP1U120-08J5</b>	
14000	G1 <sup>1</sup> / <sub>2</sub>	0... 50	R120-12J5	PP000-5000	<b>BP1U120-12J5</b>	
15000	G2	0... 50	R120-16J5	PP000-5000	<b>BP1U120-16J5</b>	

### Special options, add the appropriate letter

4-20 mA	input signal	BP1I...-....
---------	--------------	--------------



BP1U750-02



BP1U119-16



BP1UZ-08



BP1U120-08J5

Gauges: see chapter for measuring devices  
Further details: see chapter for single devices

PDF CAD  
www.aircom.net

\* Product group



Order example:  
BP1U750-02

**General operational description:**

The volume booster and proportional pressure regulator are fed by the supply pressure. When no command signal is applied the outlet pressure behind the booster is zero. When the command signal is increased the outlet pressure rises in proportion to it. Since the transmission ratio is not exactly 1:1, a slight pressure difference occurs between the outlet pressure of the proportional pressure regulator and the booster's outlet on single loop systems. This can be balanced by a feedback signal (double loop), though.

Combinations with a second feedback have the possibility to balance pressure differences. For this a pressure transducer is installed in the outlet line of the booster. The electrical signal of the transducer is applied as a feedback signal onto the proportional pressure regulator. The pressure regulator detects any pressure differences and compensates them automatically. In high flow applications a pressure drop at the outlet of the pilot regulator is thus minimised.

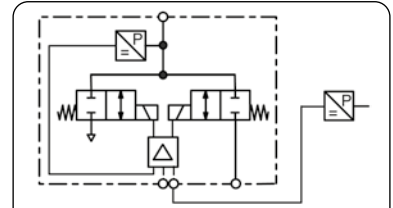

**G $\frac{1}{2}$  up to G2**  
compressed air or non-corrosive gases

## Double loop combination example

Flow rate l/min	Connection thread G	Outlet pressure		Sensor	Part number		Order number of combination	E*
		pressure bar	Sensor		Booster	Prop.press.reg.		

R450 with PQ2, for compressed air or non-corrosive gases								setpoint 0-10 V, P <sub>1</sub> max. 17 bar
4 000	G $\frac{1}{2}$	0... 1	DAV-01H	R450-04I	PQ2EE-01	<b>BP2U450-0401</b>		
		0... 6	DAV-06H	R450-04I	PQ2EE-06	<b>BP2U450-0406</b>		
		0...10	DAV-10H	R450-04I	PQ2EE-10	<b>BP2U450-0410</b>		

R200 with PQ2, for compressed air or non-corrosive gases								setpoint 0-10 V, P <sub>1</sub> max. 17 bar
28 000	G1	0... 1	DAV-01H	R200-08I	PQ2EE-01	<b>BP2U200-0801</b>		
		0... 6	DAV-06H	R200-08I	PQ2EE-06	<b>BP2U200-0806</b>		
		0...10	DAV-10H	R200-08I	PQ2EE-10	<b>BP2U200-0810</b>		

RGB4 with PQ2, for compressed air or gases								setpoint 0-10 V, P <sub>1</sub> max. 4 bar
700	G $\frac{1}{2}$	0...0.35	DAV-C4H	RGB4-04J	PQ2EE-C4	<b>BP2UGB4-04</b>		
2 800	G1	0...0.35	DAV-C4H	RGB4-08J	PQ2EE-C4	<b>BP2UGB4-08</b>		
5 600	G $\frac{1}{2}$	0...0.35	DAV-C4H	RGB4-12J	PQ2EE-C4	<b>BP2UGB4-12</b>		

RZ1 with PQ2, for compressed air or gases								setpoint 0-10 V, P <sub>1</sub> max. 16 bar
2 900	G1	0...1	DAV-01H	RZ3-08J	PQ2EE-01	<b>BP2UZ-08</b>		
5 700	G $\frac{1}{2}$	0...1	DAV-01H	RZ3-12J	PQ2EE-01	<b>BP2UZ-12</b>		
21 000	G2	0...1	DAV-01H	RZ2-16J	PQ2EE-01	<b>BP2UZ-16</b>		

## Special options, add the appropriate letter

4-20 mA      input signal      BP2I ...-....



BP2U450-0406



BP2U200-0806



BP2UGB4-12



BP2UZ-08

\* Product group

Gauges: see chapter for measuring devices  
Further details: see chapter for single devices

PDF CAD  
www.aircom.net



Order example:  
BP2U450-0401